

Switch

Tact Switch Series

TS7707 Tact Switch Series

ELECTRICAL

1. Rating: 50mA 12Vdc
2. Contact Resistance : 50mΩ Max.
3. Insulation Resistance: 100MΩ Min.
4. Dielectric Strength : AC250V(50/60Hz for 1minute)
5. Electrically Life: 80, 000cycles
6. Environment temperature: -25°C~+70°C
7. Operating Force: 250±30gf
8. Seal temperature: 260°C~ 280°C

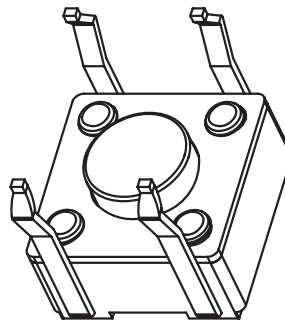
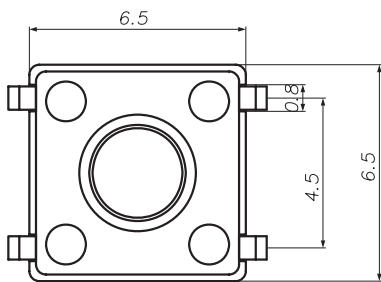
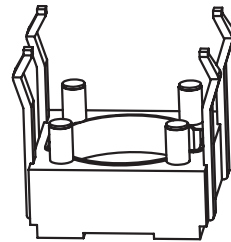
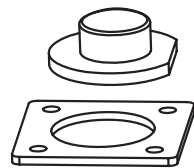
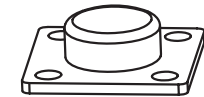
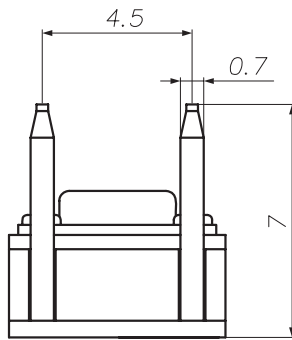
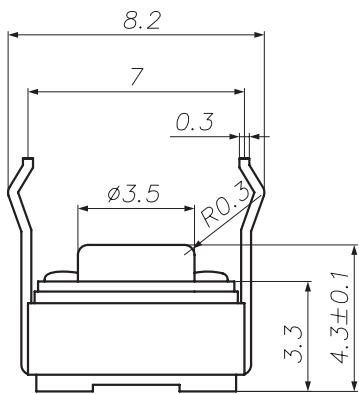

ORDER INFORMATION

