

A-TOPS ELECTRONICS COMPANY LTD

PRODUCT SPECIFICATIONS

MODULE NO.: AT430D07

For Customer:	
Approved by:	_____
Signature:	_____
Date:	_____

Please sign the cover page of the spec for your approval and return it to our local sales **within a month**

Prepared	Checked	Approved
Selina	--	--

CONTENTS

1. LCD MODULE PHYSICAL DATA2

2. OUTLINE DIMENSIONS3

3. BLOCK DIAGRAM4

4. ABSOLUTE MAXIMUM RATINGS5

5. ELECTRICAL CHARACTERISTICS6

6. ELECTRO-OPTICAL CHARACTERISTICS7

7. INTERFACE PIN CONNECTIONS9

8. RELIABILITY10

9. USING LCD MODULES11

A-TOPS ELECTRONICS COMPANY LTD

1 LCD MODULE PHYSICAL DATA

1.1 General Description

Item	Standard Value	Unit
Screen size	4.3 (16:9)	inch
Number of dots	480 RGB(H) x 272(V)	pixels
LCM dimension	105.50 (W) x67.20 (H) x 3.10(T)	mm
Active area	95.04 (H) x 53.86 (V)	mm
Pixel pitch	0.198 (H) x 0.198 (V)	mm
Driver IC	OTA5180A	--
Viewing direction	6 o'clock	--
Backlight	LED	--
Approx. weight	TBD	g

2 OUTLINE DIMENSIONS

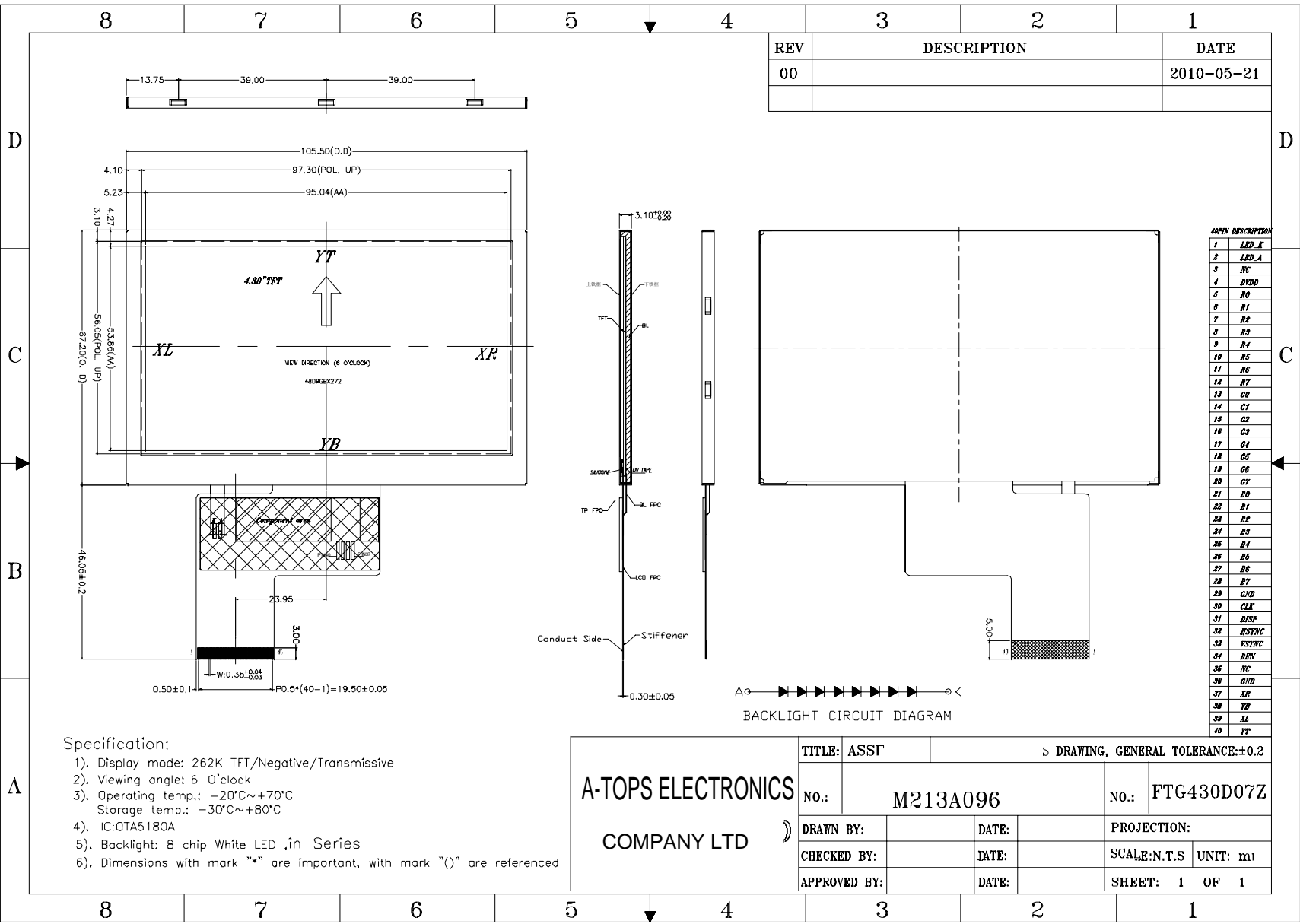

REV	DESCRIPTION	DATE
00		2010-05-21

NO.	DESCRIPTION
1	LED_K
2	LED_A
3	VC
4	PCVD
5	RO
6	R1
7	R2
8	R3
9	R4
10	R5
11	R6
12	R7
13	CB
14	C1
15	C2
16	C3
17	G1
18	G2
19	CB
20	CT
21	B0
22	B1
23	B2
24	B3
25	B4
26	B5
27	B6
28	B7
29	CND
30	CLK
31	DISP
32	BSTVC
33	VSTVC
34	BBV
35	VC
36	CND
37	XR
38	YB
39	XL
40	YT

Specification:

- 1). Display mode: 262K TFT/Negative/Transmissive
- 2). Viewing angle: 6 O'clock
- 3). Operating temp.: -20°C~+70°C
Storage temp.: -30°C~+80°C
- 4). IC:QTA5180A
- 5). Backlight: 8 chip White LED ,in Series
- 6). Dimensions with mark "*" are important, with mark "(") are referenced

A-TOPS ELECTRONICS COMPANY LTD		TITLE: ASSY	DRAWING, GENERAL TOLERANCE:±0.2	
		No.:	M213A096	No.:
DRAWN BY:		DATE:	PROJECTION:	
CHECKED BY:		DATE:	SCALE:N.T.S	UNIT: mm
APPROVED BY:		DATE:	SHEET: 1 OF 1	

3 BLOCK DIAGRAM

3.1 TFT LCD Module

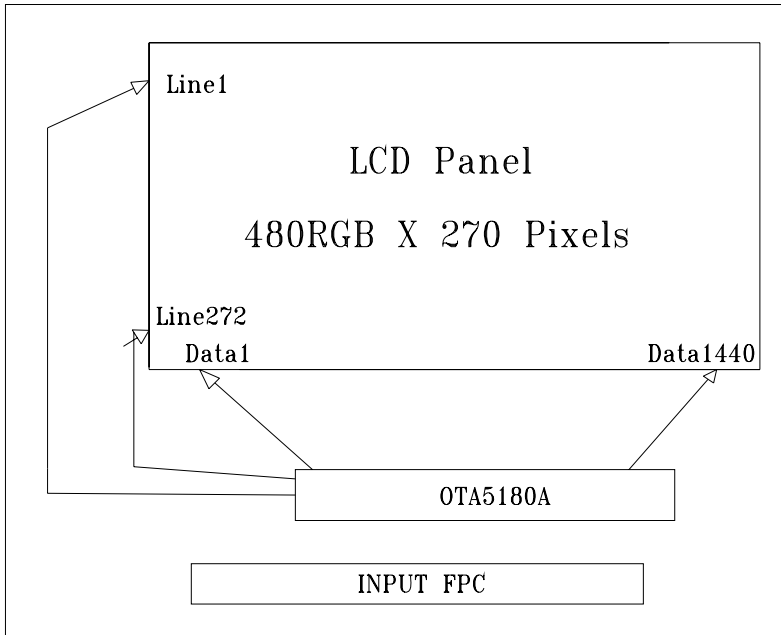

3.2 Pixel Format

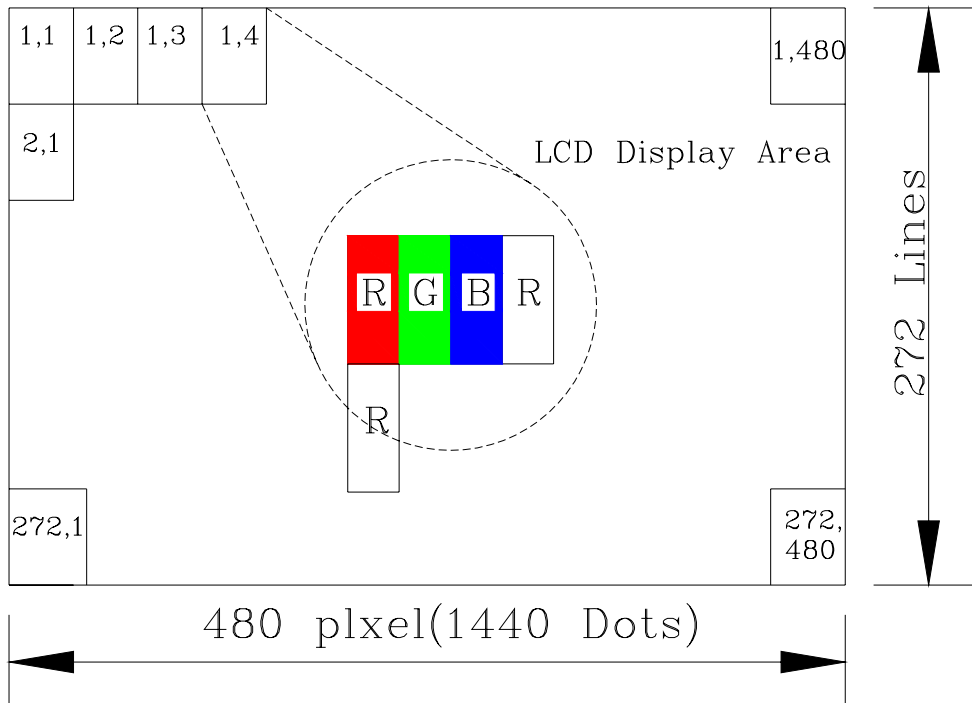

4 ABSOLUTE MAXIMUM RATINGS

ITEM	SYMBOL	CONDITION				UNIT
			MIN	TYP	MAX	
Logic power supply voltage	VDD	Ta= +25°C	-0.3	-	4.0	V
Logic input voltage	VI		-0.3	-	VDD+0.3	V
Logic output voltage	VO		-0.3	-	VDD+0.3	V
Operating Temperature	Top	---	- 20	-	+70	°C
Storage Temperature	Tst	---	- 30	-	+80	°C

NOTE:

- (1). If the module is used above these absolute maximum ratings. It may become permanently damaged. Using the module within the following electrical characteristic conditions are also exceeded, the module will malfunction and cause poor reliability
- (2). LCM should be grounded during handing LCM.
- (3). VDD>GND must be maintained.

5 ELECTRICAL CHARACTERISTICS

5.1 DC Characteristics

ITEM	SYMBOL	CONDITIONS	STANDARD VALUE			UNIT
			MIN	TYP	MAX	
Logic power supply voltage	VDD	Ta= +25°C	3.0	3.3	3.6	V
Input high voltage	VIH	—	0.8 VDD	—	VDD	V
Input low voltage	VIL	—	Vss	—	0.2 VDD	V
Clock frequency	fCLK	—	--	9	15	MHz

NOTE:

For parallel RGB interface, maximum clock frequency is 15MHz.

5.2 Back-Light unit

PARAMETER	SYMBOL	REMARK	STANDARD VALUE			UNIT
			MIN	TYP	MAX	
Forward voltage	VF	If =20mA	24.8	26.4	28.0	V
LUMINOUS INTENSITY(INCLUDE LCD)	Iv	If =20mA	180	--	-	cd/m2
Luminous tolerance	Iv-m	(min/max)/100	-	80	-	%
Chromaticity coordinates	X	If =20mA	0.250	-	<u>0.290</u>	
	Y		0.250	-	0.290	
Operating temperature	-20°C ~ 70°C					
Storage temperature	-30°C ~ 80°C					

5.3 AC Characteristics

Refer to OTA5180A data sheet.

6 ELECTRO-OPTICAL CHARACTERISTICS

Parameter	Symbol	Condition	Min	Typ	Max	Unit	Note	
Viewing angle	Left	CR>10	TBD	45	--	Degree	(2)	
	Right		TBD	45	--	Degree		
	Up		TBD	15	--	Degree		
	Down		TBD	35	--	Degree		
Color Chromaticity (CIE1931)	White	Wx	$\theta = 0$ Normal Viewing angle	TBD	0.311	TBD	--	(1)(4)
		Wy		TBD	0.349	TBD	--	
Contrast ratio		CR		150	250	--	--	(1)(2)
White Luminance (center)		YL		160	260	--	cd/m2	(1)(4)
Response time		Tr+Tf	--	20	--	ms	(3)	

Notes (1) : Contrast Ratio(CR) is defined mathematically as:

Measured at the center point of panel

$$\text{Contrast Ratio} = \frac{\text{Surface Luminance with all white pixels}}{\text{Surface Luminance with all black pixels}}$$

Note (2): Definition of viewing angle

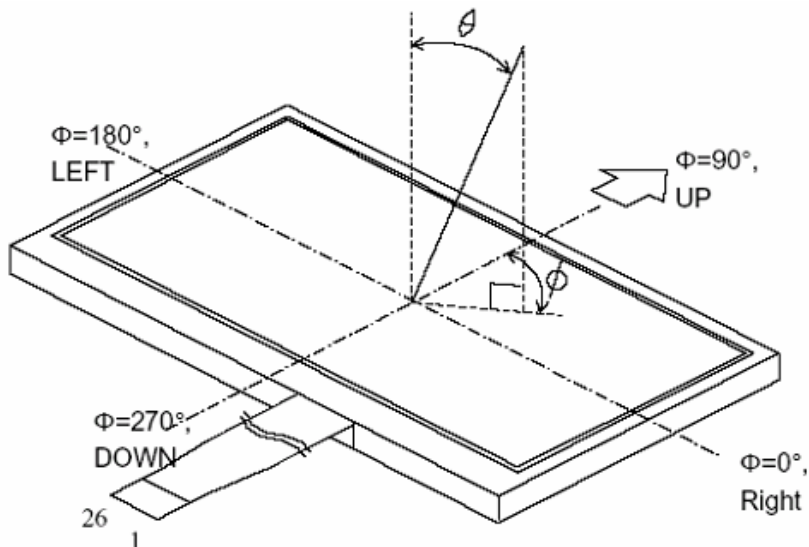

Note (3): Definition of response time: $T_r + T_f$

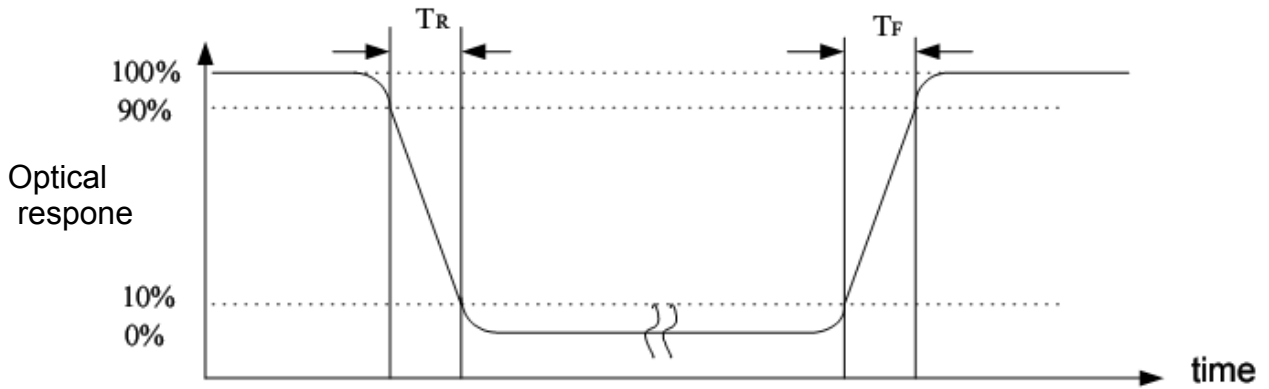

Note (4): Optical test equipment

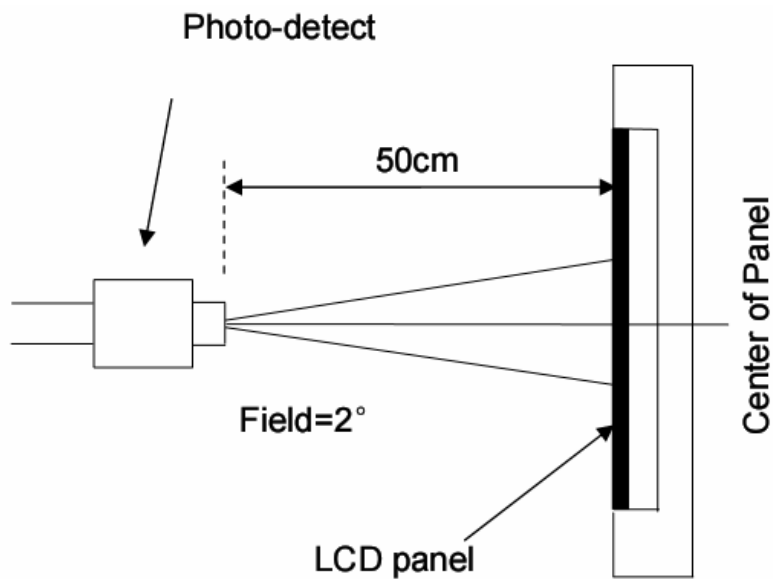

7 INTERFACE PIN CONNECTIONS

PIN NO.	SYMBOL	I/O	FUNCTION DESCRIPTIONS	Note
1	LED-K	P	The backlight ground.	
2	LED-A	P	Power supply for backlight.	
3	NC	--	No connect	
4	VDD	P	Supply voltage of logic control circuit	
5~12	R0~R7		Red data	
13~20	G0~G7		Green data	
21~28	B0~B7		Blue data	
29	GND	P	Ground	
30	CLK	I	Dot clock signal	
31	DISP		Display on/off. DISP=L:display off.	
32	HSYNC	I	Horizontal sync input	
33	VSYNC	I	Vertical sync input	
34	DEN	I	Input data enable control.	
35	NC	--	No connect	
36	NC	--	No connect	
37	XR		Touch Screen Connected	
38	YB			
39	XL			
40	YT			

Note:

I: input signal
P: power supply

8 RELIABILITY

NO.	Test Item	Description	Test Condition
1	High temperature storage	Endurance test applying the high storage temperature for a long time	70°C,240 H
2	Low temperature storage	Endurance test applying the low storage temperature for a long time	-20°C,240H
3	High temperature operation	Endurance test applying the electric stress under high temperature for a long time	60°C,96H
4	Low temperature operation	Endurance test applying the electric stress under low temperature for a long time	-10°C,96H
5	High temperature /humidity storage	Endurance test applying the high temperature and high humidity storage for a long time	50°C, 90% R.H 240H
6	High temperature /humidity operation	Endurance test applying electric stress under high temperature and high humidity for a long time	40°C 90% R.H 96H
7	Temperature Cycle	Endurance test applying the low and high temperature cycle -20°C → 25°C → 70°C →25°C 30min 5min 30min 5min one cycle	-20°C/70°C 10 cycles
8	Vibration test	Endurance test applying the vibration during transportation and using	10Hz~50Hz Swing:0.75mm time:30min
9	Fall test	Endurance test dropping the LCM from a high place	600mm height
10	Static electricity test	Endurance test applying static electric stress to terminal	Contact discharge: ±2KV~4KV Air discharge: ±2KV~10KV

NOTE: TEST CONDITION

- (1) Temperature and humidity: If no specification, temp. set at 25±2°C, humidity set at 60±5%RH.
- (2) Operating state: Samples subject to the test shall be in “operating” condition.

9 USING LCD MODULES

9.1 LIQUID CRYSTAL DISPLAY MODULES

LCD is composed of glass and polarizer. Pay attention to the following items when handling.

- (1) Please keep the temperature within specified range for use and storage. Polarization degradation, bubble generation or polarizer peel-off may occur with high temperature and high humidity.
- (2) Do not touch, push or rub the exposed polarizers with anything harder than an HB pencil lead (glass, tweezers, etc.).
- (3) N-hexane is recommended for cleaning the adhesives used to attach front/rear polarizers and reflectors made of organic substances which will be damaged by chemicals such as acetone, toluene, ethanol and isopropylalcohol.
- (4) When the display surface becomes dusty, wipe gently with absorbent cotton or other soft material like chamois soaked in petroleum benzine. Do not scrub hard to avoid damaging the display surface.
- (5) Wipe off saliva or water drops immediately, contact with water over a long period of time may cause deformation or color fading.
- (6) Avoid contacting oil and fats.
- (7) Condensation on the surface and contact with terminals due to cold will damage, stain or dirty the polarizers. After products are tested at low temperature they must be warmed up in a container before coming in contact with room temperature air.
- (8) Do not put or attach anything on the display area to avoid leaving marks on.
- (9) Do not touch the display with bare hands. This will stain the display area and degrade insulation between terminals (some cosmetics are determined to the polarizers).
- (10) As glass is fragile. It tends to become cracked or chipped during handling especially on the edges. Please avoid dropping or rising.

9.2 PRECAUTION FOR HANDLING LCD MODULES

Since LCM has been assembled and adjusted with a high degree of precision, avoid applying excessive shocks to the module or making any alterations or modifications to it.

- (1) Do not alter, modify or change the shape of the tab on the metal frame.
- (2) Do not make extra holes on the printed circuit board, modify its shape or change the positions of components to be attached.
- (3) Do not damage or modify the pattern writing on the printed circuit board.
- (4) Absolutely do not modify the zebra rubber strip (conductive rubber) or heat seal connector.
- (5) Except for soldering the interface, do not make any alterations or modifications with a soldering iron.
- (6) Do not drop, bend or twist LCM.
- (7) In order to avoid the cracking of the FPC, you should pay attention to the area of FPC(R50mm) where the FPC was bent. the edge of coverlay; the area of surface of Ni-Au plating, the area of soldering land, the area of through hole.

9.3 ELECTRO-STATIC DISCHARGE CONTROL

Since this module uses a CMOS LSI, the same careful attention should be paid to electrostatic discharge as for an ordinary CMOS IC.

- (1) Make certain that you are grounded when handling LCM.
- (2) Before remove LCM from its packing case or incorporating it into a set, be sure the module and your body have the same electric potential.
- (3) When soldering the terminal of LCM, make certain the AC power source for the soldering iron does not leak.
- (4) When using an electric screwdriver to attach LCM, the screwdriver should be of ground potentiality to minimize as much as possible any transmission of electromagnetic waves produced sparks coming from the commutator of the motor.
- (5) As far as possible make the electric potential of your work clothes and that of the work bench the ground potential.
- (6) To reduce the generation of static electricity be careful that the air in the work is not too dried. A relative humidity of 0%-60% is recommended.

9.4 PRECAUTIONS FOR OPERATION

- (1) Viewing angle varies with the change of liquid crystal driving voltage (VO). Adjust VO to show the best contrast.
- (2) Driving the LCD in the voltage above the limit shortens its life.
- (3) Response time is greatly delayed at temperature below the operating temperature range. However, this does not mean the LCD will be out of the order. It will recover when it returns to the specified temperature range.
- (4) If the display area is pushed hard during operation, the display will become abnormal. However, it will return to normal if it is turned off and then back on.
- (5) Condensation on terminals can cause an electrochemical reaction disrupting the terminal circuit. Therefore, it must be used under the relative condition of 40°C , 50% RH.
- (6) When turning the power on, input each signal after the positive/negative voltage becomes stable.

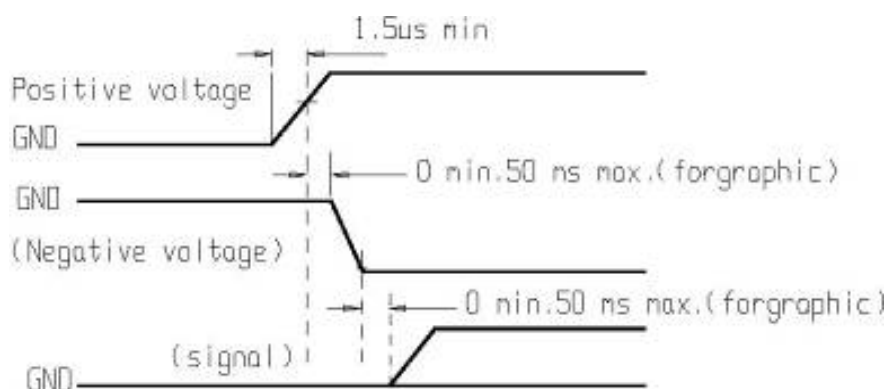

9.5 STORAGE

When storing LCDs as spares for some years, the following precaution are necessary.

- (1) Store them in a sealed polyethylene bag. If properly sealed, there is no need for dessicant.
- (2) Store them in a dark place. Do not expose to sunlight or fluorescent light, keep the temperature between 0°C and 35°C.
- (3) The polarizer surface should not come in contact with any other objects. (We advise you to store them in the container in which they were shipped.)
- (4) Environmental conditions :
 - Do not leave them for more than 160hrs. at 70°C.
 - Should not be left for more than 48hrs. at -20°C.

9.6 SAFETY

- (1) It is recommended to crush damaged or unnecessary LCDs into pieces and wash them off with solvents such as acetone and ethanol, which should later be burned.
- (2) If any liquid leaks out of a damaged glass cell and comes in contact with the hands, wash off thoroughly with soap and ater.

Module repairs will be invoiced to the customer upon mutual agreement. Modules must be returned with sufficient description of the failures or defects. Any connectors or cable installed by the customer must be removed completely without damaging the PCB's eyelet, conductors and terminals.