

### 3、VTG Series (105°C,3000H)

#### (1)、Standard Rating 基本参数

No.	Item	Ratings		
1	Temperature Range 使用温度范围	- 25~+105°C		
2	Rated Voltage Range 额定电压范围	250~400V		
3	Capacitance Range 标称容量范围	2.2~22 μ F		
4	Capacitance Tol 容量容许偏差	±20% (120Hz, 20°C)		
5	Surge Voltage 浪涌电压(V.DC)	R.V.	250	400
		S.V.	275	440

#### (2)、Electrical Requirements 电性能要求

1	Capacitance Tolerance 容量允许偏差	±20% at 120Hz,20°C								
2	Operation Temperature Range 使用温度范围	250V~400V -25°C~+105°C								
3	Leakage Current 漏电流	<p>After DC Voltage is applied to capacitor through the series protective resistance(1K Ω ),and then terminal voltage may reach the rated working voltage. The leakage current when measured after 1minutes 250~400V) shall be below the value of the following equation.</p> <p>将电容器串联 1K Ω 电阻后，施加额定直流电压 1 分钟，测量漏电流满足以下要求。</p> <div style="border: 1px solid black; padding: 5px; width: fit-content; margin: 10px auto;"> <p>250~400V  <math>I \leq 0.04CV + 100</math>            Whichever is greater</p> </div> <div style="border: 1px solid black; padding: 5px; width: fit-content; margin: 10px auto;"> <p>Where      I=Leakage Current( μ A)                         C=Capacitance( μ F)                         V=Rated DC Working Voltage(V)</p> </div>								
4	Dissipation Factor 损耗角正切值 (Tan δ at 120Hz,20°C)	<table border="1" style="width: 100%; border-collapse: collapse;"> <tbody> <tr> <td style="text-align: center;">Rated Voltage</td> <td style="text-align: center;">250</td> <td style="text-align: center;">400</td> </tr> <tr> <td style="text-align: center;">Tan δ (max)</td> <td style="text-align: center;">0.20</td> <td style="text-align: center;">0.22</td> </tr> </tbody> </table>			Rated Voltage	250	400	Tan δ (max)	0.20	0.22
Rated Voltage	250	400								
Tan δ (max)	0.20	0.22								

5	Low Temperature Characteristics 低温特性 (at 120Hz)	<table border="1"> <tr> <td colspan="2">Rated Voltage</td> <td>250</td> <td>400</td> </tr> <tr> <td>Impedance Ratio</td> <td>Z(-25°C)/Z(+20°C)</td> <td>3</td> <td>6</td> </tr> </table>				Rated Voltage		250	400	Impedance Ratio	Z(-25°C)/Z(+20°C)	3	6
		Rated Voltage		250	400								
Impedance Ratio	Z(-25°C)/Z(+20°C)	3	6										
6	Rated Ripple Current 纹波电流 (at 120Hz,105°C)	电压 (V)	250 (2E)		400 (2G)								
		壳号 μF	side mm	Ripple Current mA	side mm	Ripple Current mA							
		1			6.3×10.5	21							
		2.2	6.3×10.5	21	8×10.5 6.3×10.5	30 24							
		3.3			10×10.5 8×10.5	45 31							
		4.7	8×10.2 6.3×10.5	30 24	10×10.5 8×12.5	49 47							
		6.8	8×10.5	33	10×12.5 10×10.5	70 64							
		8.2			10×12.5	85							
		10			12.5×13.5 10×12.5	135 85							
		15			12.5×13.5	135							
		22			16×16.5	205							

(4)、Experiment the method and request 试验方法及要求

No.	Item 项目	Performance Characteristics 性能要求	Test 测试		
			Step	Test Temperature	Time
1	Characteristics at High and Low Temperature 高低温特性	<u>Step2 (阶段 2)</u> Impedance Ratio: (阻抗比) Less than the item 5 Value of page 5 Ratio against step 1 相对于阶段 1 比值小于第 5 页第 5 项中的值 <u>Step4 (阶段 4)</u> Leakage Current: (漏电流) Less than 800% of the value of item 3 at P4 小于或等于第 4 页第 3 项规定值 8 倍 Capacitance Change: (容量变化) Within ±20% of the value in step1 与阶段 1 的 值比变化率在 ±20% 范围内	1	20±2°C	3min
			2	-25±3°C	30min
			3	20±2°C	3min
			4	105±2°C	30min
			5	20±2°C	3min

2	Surge Voltage Test 浪涌测试	<p>Leakage Current: (漏电流) Less than the value of item 3 of page 4 ≤第4页第3项规定值</p> <p>Capacitance Change: (容量变化) Within ±15% of the initial measured value 与初始测量值比变化率±15%范围内</p> <p>Tangent of Loss Angle: (损耗角正切值) Less than 130% of specified value ≤第4页第4项规定值的130%.</p>	<p>After surge voltage(the value of item 5 of P4) applied at a cycling rate of 30 seconds charge and 5.5 minutes discharge 1000 successive test cycle. Test temperature:15~35°C. 对电容器施加浪涌电压,每充电30s,放电5min30sec,连续循环1000次后测量。测试温度:15~35°C。</p>
3	Tensile Test 拔出力测试	<p>No broken and undamaged 无损坏</p>	<p>After fixing the capacitors, the terminals are pulled in vertical direction. Load is gradually increased until it reached 5N and held for 10 sec. 将电容器固定,在电容器的垂直方向上逐渐增加砝码至5N,然后持续10s结束。</p>
4	Solderability 可焊性	<p>More than 95% of the terminal surface shall be covered with new solder. 引线端子表面95%以上的面积附着新焊料。</p>	<p>Temperature: 235±2°C (温度) Immersing Time: 2±0.1sec (浸入时间) Immersing Depth: Dip the terminal for Approx. 0.5~1mm thick 浸入深度: 浸入引线约0.5~1mm Flux: Approx. 25% rosin in Ethanol 助焊剂: 约25%的松香溶于酒精</p>
5	Vibration 振动	<p>Capacitance: (容量) During test, measured value shall be stabilized (measured several times within 30 min. Before completion of test) 在测试的30分钟内,观测电容量测试值无明显变化</p> <p>Appearance: (外观) No significant change can be observe 无可见损伤</p> <p>Capacitance change: (容量变化) Within ±10% of initial measured value 容量变化率在±10%范围内</p>	<p>Frequency: 10~55Hz reciprocation for 1 min 频率: 10到55Hz,每分钟互换</p> <p>Total amplitudes: 0.75mm 振幅: 0.75mm</p> <p>Direction and during of vibration: 3 orthogonal directions, Mutually each for 2hrs total 6hrs 在互相垂直的3个方向上,每个方向振动2小时,共6小时。</p>
6	Solder Heat-Resistance Test 耐焊接热	<p>Appearance: (外观) No significant change can be observe 无可见损伤</p> <p>Capacitance change: (容量变化) Within ±10% of initial measured value 容量变化率在±10%范围内</p>	<p>After reflow soldering the capacitor shall be restored to 20°C within two hours or over an hour. 将电容器通过回流焊后,在室温(20°C)恢复1~2小时。</p>
7	Solvent Resistance of the Marking 标示耐溶剂性	<p>There shall be no damage and legibly marked. Marking can be deciphered easily. 标示应清晰可辨</p>	<p>Class of Reagent: Isopropyl Alcohol 试剂: 异丙醇</p> <p>Test Temperature: 20~25°C 温度: 20~25°C</p> <p>Immersing Time: 5 minutes 浸入时间: 5分钟</p>

8	Humidity Test 潮湿试验	<p>Leakage Current: (漏电流) Less than the value of item 3 of page4 ≤第4页第3项规定值</p> <p>Capacitance Change: (容量变化) Within ±20% of the initial measured value 与初始测量值比变化率在±20%范围内。</p> <p>Tangent of Loss Angle: (损耗角正切值) Less than 120% of the value of item 4 of page 4 ≤第4页第4项规定值的1.2倍</p> <p>Appearance: (外观) No significant change can be observed.无可见损伤</p>	<p>Capacitors shall be exposed for 500 ± 6hrs in an atmosphere of 90~95% R.H. at 40 °C. And then the capacitor shall be subjected to standard atmospheric conditions for 1-2 hours, after which measurements shall be made.</p> <p>电容器放置在温度 40°C、湿度 90~95%的环境下 500 ± 6 小时，然后放置在标准环境中恢复 1-2 小时</p>
9	High Temperature Load Life Test 高温负荷寿命	<p>Leakage Current: (漏电流) Less than the value of item 3 of page 4 ≤第4页第3项规定值</p> <p>Capacitance Change: (容量变化) Within ±20% of the initial measured value 与初始测量值比变化率在±20%范围内。</p> <p>Tangent of Loss Angle: (损耗角正切值) Less than 200% of the value of item 4 of page 4 ≤第4页第4项规定值的2倍</p> <p>Appearance: (外观) No significant change can be observed.无可见损伤</p>	<p>Test Temperature 温度: 105 ± 2°C</p> <p>Test Duration: 3000hours 试验持续时间: 3000 小时</p> <p>Applied Voltage: Rated Voltage 施加电压: 额定电压</p> <p>After subjected to the test, the capacitors shall be left at the room temperature for 16 hours prior to the measurement. 试验完成后，电容器在测量前应在室温中恢复 16 小时。</p>
10	High Temperature Unload Life Test 高温储存	<p>Leakage Current: (漏电流) Less than 200% of the value of item 3 of page4 ≤第4页第3项规定值的2倍</p> <p>Capacitance Change: (容量变化) Within ±20% of the initial measured value 与初始测量值比变化率在±20%范围内</p> <p>Tangent of Loss Angle: (损耗角正切值) Less than 200% of specified value of item 4 of page 4 ≤第4页第4项规定值的2倍</p> <p>Appearance: (外观) No significant change can be observed.无可见损伤</p>	<p>Test Temperature 温度: 105 ± 2°C</p> <p>Test Duration: 1000hours 试验持续时间: 1000 小时</p> <p>After subjected to the test, the capacitors shall be left at the room temperature for 16 hours prior to the measurement. 试验完成后，电容器在测量前应在室温中恢复 16 小时。</p>

(5)、Dimension & Appearance 外形尺寸

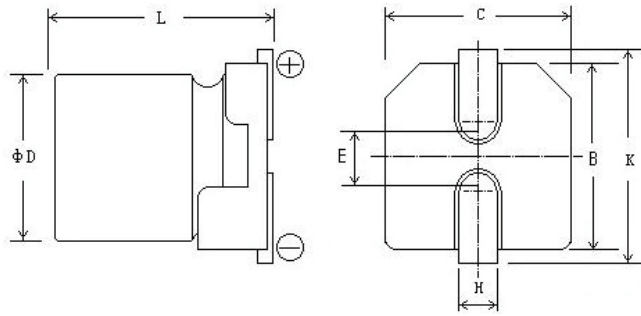

	φ 6.3×10.5	φ 8×10.2	φ 8×12.5	φ 10×10.2	φ 10×12.5	φ 12.5×13.5	φ 16×16.5
B±0.2	6.6	8.3	8.3	10.3	10.3	13.0	17
C±0.2	6.3	8.3	8.3	10.3	10.3	13.0	17
E	2.2	3.1	3.1	4.5	4.5	5.2	6.5
L±0.3	10.5	10.5	12.5	10.5	12.5	13.5	16.5
K±0.2	7.1	9.1	9.1	11.1	11.1	13.8	18
H	0.5~0.9	0.8~1.1				1.0~1.6	

4、Marking 标示

a) Following items shall be marked on the body of capacitor. The marking color is black.

电容器的本体上印刷以下内容，颜色为黑色。

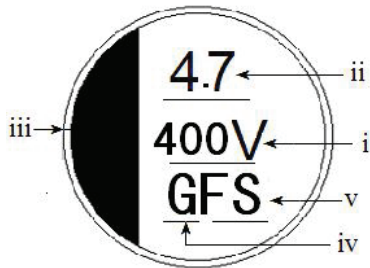

- i. Rated Voltage      额定电压
- ii. Capacitance      额定容量
- iii. Negative Polarity      负极标示
- iv. Series      系列代码
- v. Code      代码

b) Following items should be marked on the taping reel.

电容器的编带包装盘上印刷以下内容。

- i. Rated Voltage and Capacitance      额定电压&容量
- ii. Manufacture's Name      制造商名称
- iii. Customer's Part Number(if request)      客户料号（客户有要求时）
- iv. Series Mark      系列名称
- v. Lot Number      制造批号
- vi. Packing quantity      编带数量

## 5、Taping shapes & Dimensions 编带尺寸 (单位: mm)

### ● Carrier tape 编带

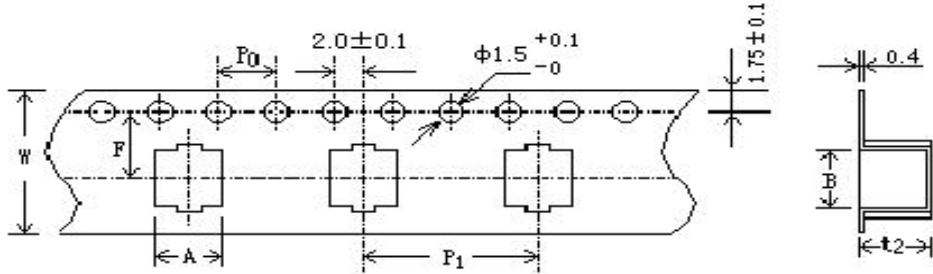

$\phi D \times L$	$W \pm 0.3$	$A \pm 0.2$	$B \pm 0.2$	$F \pm 0.1$	$P_1 \pm 0.1$	$t_2 \pm 0.2$
$\phi 6.3 \times 10.5$	16.0	7.0	7.0	7.5	12.0	11.0
$\phi 8 \times 10.2$	24.0	8.7	8.7	11.5	16.0	11.0
$\phi 10 \times 10.2$	24.0	10.7	10.7	11.5	16.0	11.0
$\phi 10 \times 12.5$	24.0	10.7	10.7	11.5	16.0	14.0
$\phi 12.5 \times 13.5$	32.0	13.4	13.4	14.2	24.0	14.4
$\phi 16 \times 16.5$	44.0	17.5	17.5	20.2	28.0	17.4

### ● Reel 编带包装盘

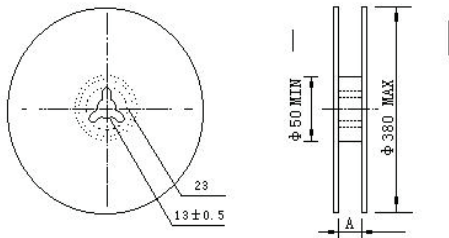

$\phi D$	6.3	8	10	12.5	16
A	18	26	26	24	46

## 6、Adhesion Test 编带粘接力测试

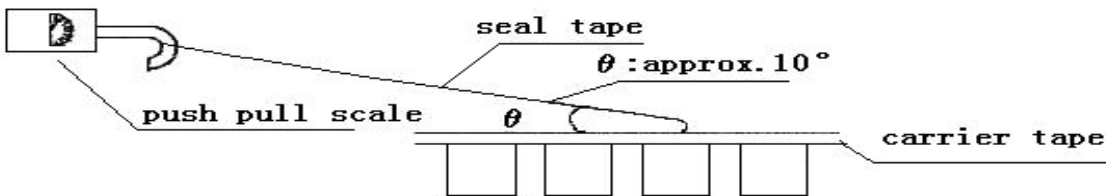

Reasonable pulling strength: 0.1~0.7N; Pulling speed: 200~300mm/min.

适当的粘接力强度: 0.1~0.7N; 测试速度: 200~300mm/min

## 7、Details of Carrier Tape 编带补充说明

(1) 收料卷动开始时 Reeling begin:

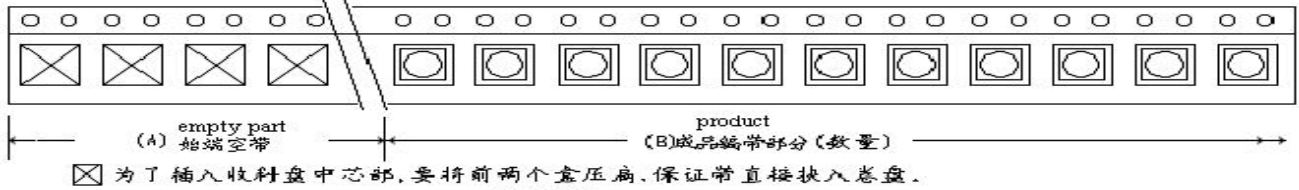

(2) 收料卷动结束时 Reeling over:

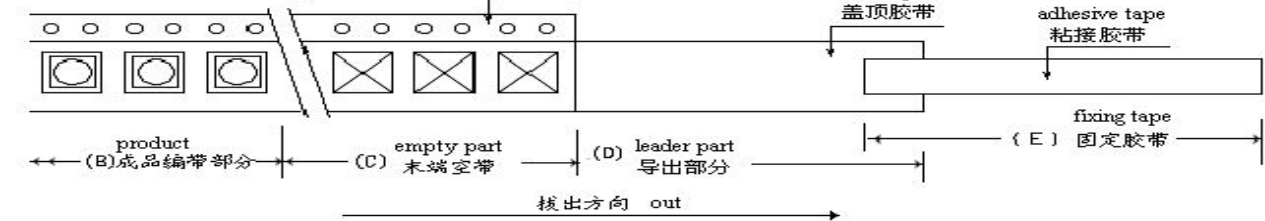

Last reeling empty part of carrier tape shall be more than 10cm. 每盘编带产品的末端空带不少于 10cm。

Leader part of seal tape shall be more than 20cm. 结尾处盖顶胶带的导出部分不少于 20cm。

Adhesive tape fixing the end of the leader part shall be approx. 10cm. 粘接盖顶胶带的固定胶带长约 10cm。

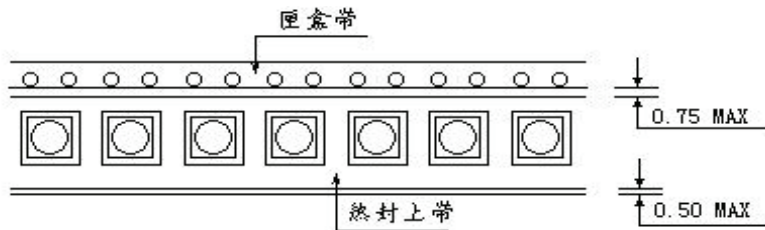

Deviation between carrier tape and seal tape shall be less than 0.5mm (Drawing 1).

盖顶胶带的偏移不超过 0.5mm。

Seal tape shall not cover on the feeling hoers .

盖顶胶带不可覆盖导带孔的部分。

## 8、imensions of Outer Carton Box 外包装箱尺寸

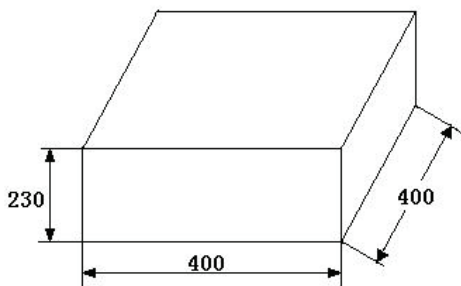

Drawing 3

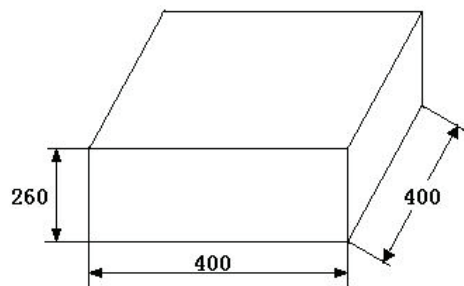

Drawing 4

### 9、Packing Quantity 包装数量

Size	Quantity/one reel/(pcs)	Quantity/one box/(pcs)	Outer box size
$\phi 6.3 \times 10.5$	500	3000	Drawing 3
$\phi 8 \times 10.5$	500	3000	Drawing 3
$\phi 8 \times 12.5$	500	3000	Drawing 3
$\phi 10 \times 10.5$	500	3000	Drawing 3
$\phi 10 \times 12.5$	400	2400	Drawing 3
$\phi 12.5 \times 13.5$	300	1500	Drawing 4
$\phi 16 \times 16.5$	125	500	Drawing 3

### 10、Fixing 安装

Recommend land size 建议安装尺寸

尺寸 side	X	Y	a
$\Phi 6.3$	1.6	3.5	2.1
$\Phi 8$	2.5	3.5	3.0
$\Phi 10$	2.5	4.0	4.0
$\Phi 12.5$	2.5	6.0	5.0
$\Phi 16$	3.0	6.5	8.0

#### ■ 回流焊温度与时间曲线 Temperature/ Time profile

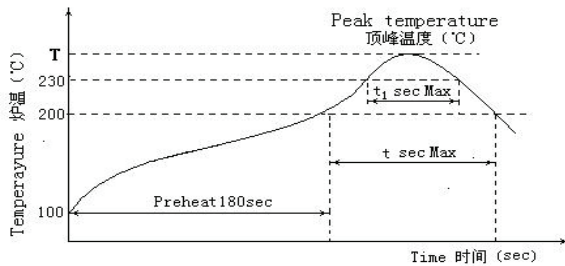

#### ■ 不同壳号的焊接温度及时间 Allowable Range of Peak Temperature

Size	T(°C)	t (second)	t <sub>1</sub> (second)
$\phi 6.3$	245	90	40
$\phi 8$	245	90	40
$\phi 10$	245	90	40
$\Phi 12.5 \sim 16$	245	90	40

- Preheat shall be made at 100°C ~ 200°C and for maximum 180 seconds.  
100~200°C的预热时间不超过 180 秒。
- If capacitors are subject to the conditions other than the allowable range of reflow , please contact to us.  
如果电容器承受的条件与回流焊的允许范围不同，请与我们联系。