

Features

- $R_{DS(ON)} \leq 100m\Omega @ V_{GS}=10V$
- Super high density cell design for extremely low $R_{DS(ON)}$
- Exceptional on-resistance and maximum DC current

Application

- Power Management in Note book
- DC/DC Converter
- Load Switch
- LCD Display inverter

Package and Pin Configuration

(TO-252-3L)

Top View

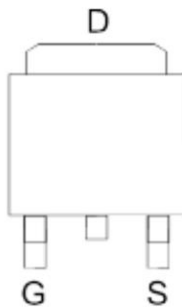

Circuit diagram

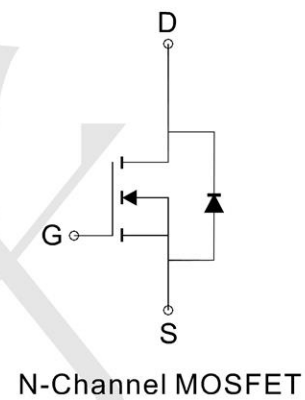

Marking:



Absolute Maximum Ratings (T_c=25°C unless otherwise specified)

Parameter	Symbol	Maximum Ratings	Unit
Drain-Source Voltage	V _{DS}	100	V
Gate-Source Voltage	V _{GS}	±20	V
Continuous Drain Current	I _D	T _c =25°C	14.7
		T _c =70°C	13.6
Pulsed Drain Current	I _{DM}	59	A
Maximum Power Dissipation	P _D	T _c =25°C	34.7
		T _c =70°C	22.2
Junction and Storage Temperature Range	T _J , T _{stg}	-55 to 150	°C
Thermal Resistance-Junction to Case *	R _{θJC}	3.6	°C/W

Electrical Characteristics ($T_J=25^\circ\text{C}$ unless otherwise specified)

Symbol	Parameter	Limit	Min	Typ	Max	Unit
STATIC						
BV _{DSS}	Drain-Source Breakdown Voltage	V _{GS} =0V, I _D =250 μ A	100			V
V _{GS(th)}	Gate Threshold Voltage	V _{DS} =V _{GS} , I _D =250 μ A	1		3	V
I _{GSS}	Gate Leakage Current	V _{DS} =0V, V _{GS} = \pm 20V			\pm 100	nA
I _{DSS}	Zero Gate Voltage Drain Current	V _{DS} =80V, V _{GS} =0V			1	μ A
R _{DS(ON)}	Drain-Source On-Resistance ^a	V _{GS} =10V, I _D =8A		80	100	m Ω
V _{SD}	Diode Forward Voltage	I _S =8A, V _{GS} =0V		0.9	1.2	V
DYNAMIC						
Q _g	Total Gate Charge	V _{DS} =80V, V _{GS} =10V, I _D =10A		24		nC
Q _g	Total Gate Charge	V _{DS} =80V, V _{GS} =4.5V, I _D =10A		13		
Q _{gs}	Gate-Source Charge			4.6		
Q _{gd}	Gate-Drain Charge			7.6		
C _{iss}	Input Capacitance	V _{DS} =15V, V _{GS} =0V, f=1MHz		882		pF
C _{oss}	Output Capacitance			57		
C _{rss}	Reverse Transfer Capacitance			44		
t _{d(on)}	Turn-On Delay Time	V _{DS} =50V, R _L =5 Ω , V _{GS} =10V, R _G =1 Ω I _D =1A		14		ns
t _r	Turn-On Rise Time			33		
t _{d(off)}	Turn-Off Delay Time			39		
t _f	Turn-Off Fall Time			5		

Typical Electrical and Thermal Characteristic Curves

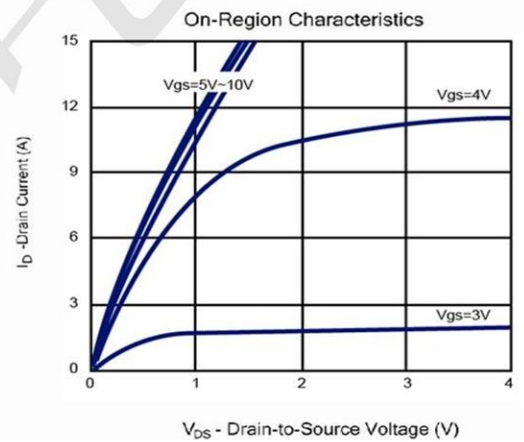
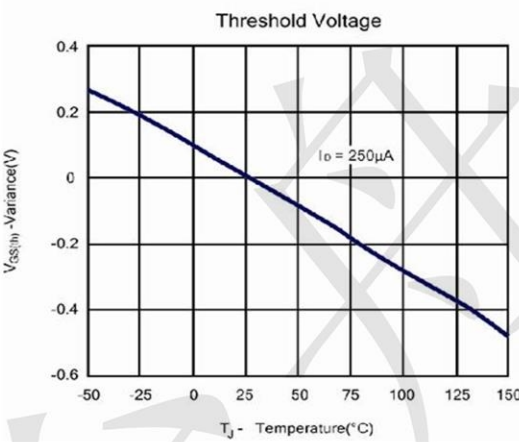
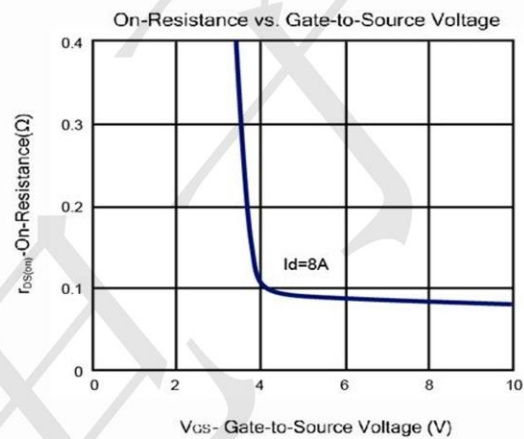
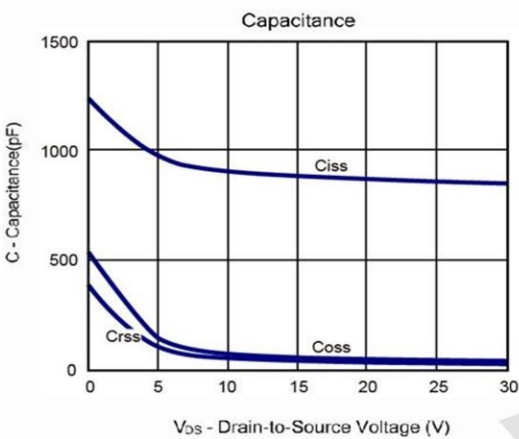
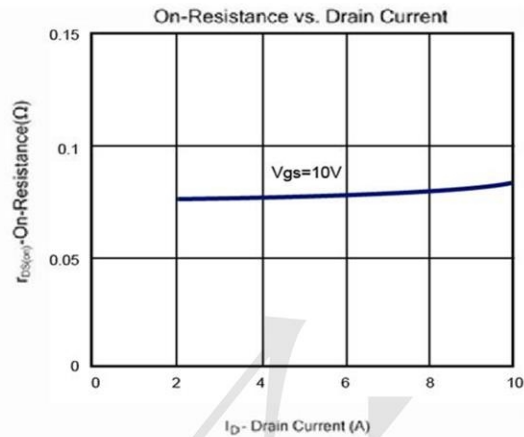
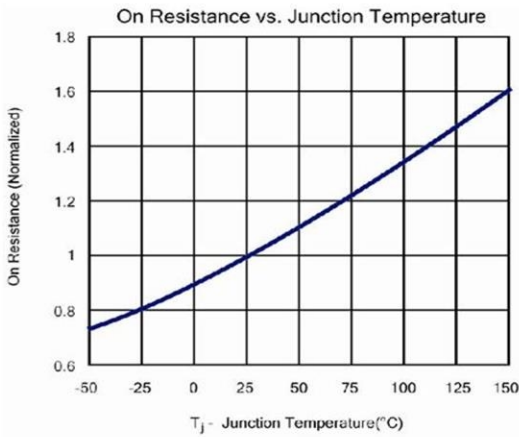

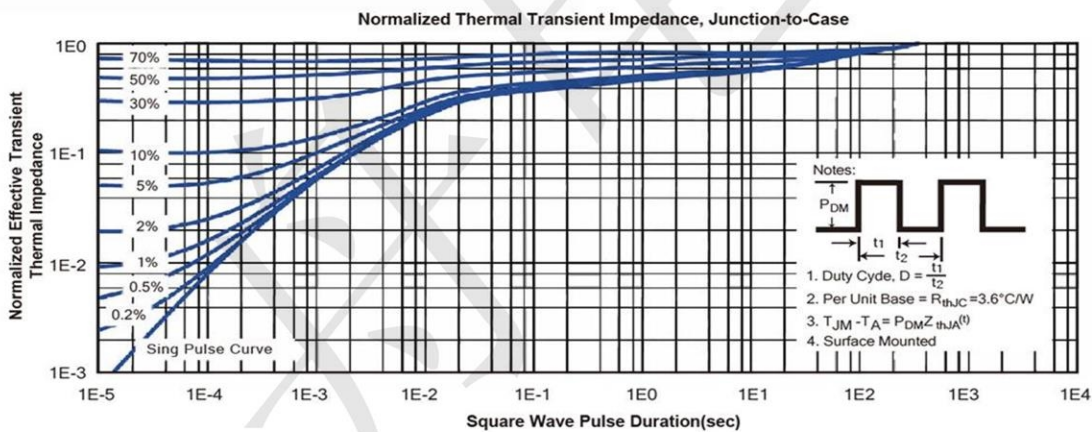
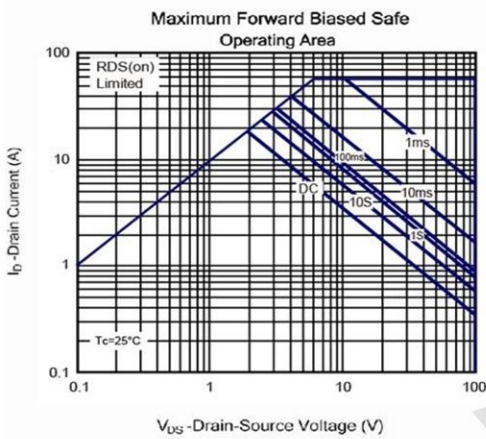
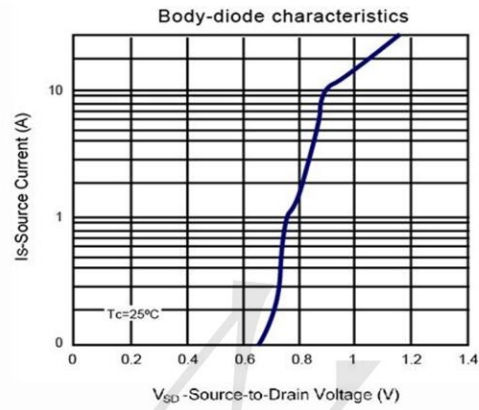
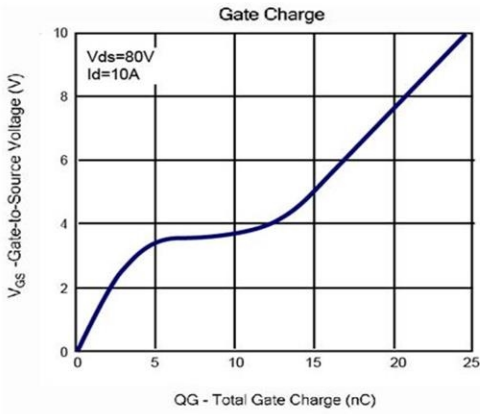

TO252 Package Information

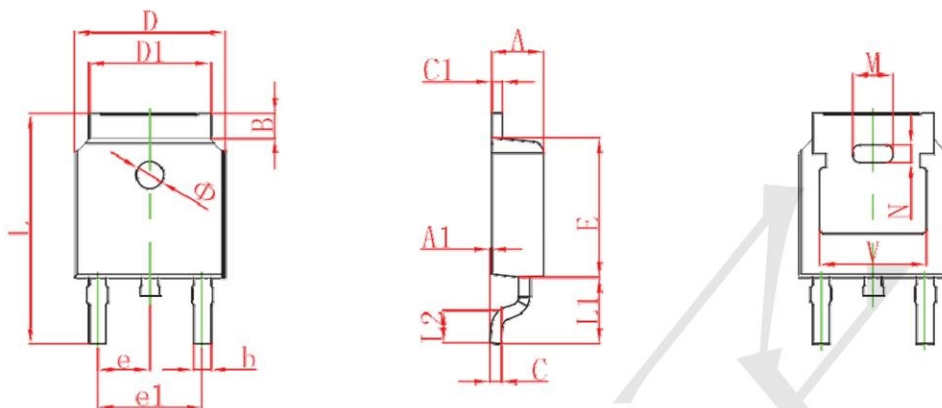

Symbol	Dimensions In Millimeters		Dimensions In Inches	
	Min.	Max.	Min.	Max.
A	2.200	2.380	0.087	0.094
A1	0.000	0.100	0.000	0.004
B	0.800	1.400	0.031	0.055
b	0.710	0.810	0.028	0.032
c	0.460	0.560	0.018	0.022
c1	0.460	0.560	0.018	0.022
D	6.500	6.700	0.256	0.264
D1	5.130	5.460	0.202	0.215
E	6.000	6.200	0.236	0.244
e	2.286 TYP.		0.090 TYP.	
e1	4.327	4.727	0.170	0.186
M	1.778REF.		0.070REF.	
N	0.762REF.		0.018REF.	
L	9.800	10.400	0.386	0.409
L1	2.9REF.		0.114REF.	
L2	1.400	1.700	0.055	0.067
V	4.830 REF.		0.190 REF.	
⌀	1.100	1.300	0.043	0.0±1