

	DATE	06-07-2020	SPECIFICATION	ChangZhou Cre-Sound Electronics Co.,Ltd.
	PAGE	1/9		www.cre-soundbuzzer.com
	Rev.	A/1		www.wj-Lianhua.com
<i>MODEL NAME: LPT2270AS-HS-12-4.0-19-R</i>				

SPECIFICATION FOR APPROVAL

SMD PIEZO TRANSDUCER

Model Name	LPT2270AS-HS-12-4.0-19-R
Note	

Product Photo	Cre-Sound
	DRAWING: 曹佳镇

ChangZhou Cre-Sound Electronics Co.,Ltd.
Tel: +86-519-86323596; Fax: +86-519-86702455
E-mail:sales5@wj-lianhua.com

	CHECKED: 韦 娟
	APPROVED: 宋雪琪
Customer Confirmation:	

	DATE	06-07-2020	SPECIFICATION	ChangZhou Cre-Sound Electronics Co.,Ltd.
	PAGE	2/9		www.cre-soundbuzzer.com
	Rev.	A/1		www.wj-Lianhua.com
<i>MODEL NAME: LPT2270AS-HS-12-4.0-19-R</i>				

Alteration History						
Change NO.	Note	Before of changes	After of changes	Reason	Revision by	Rev.
F20200328021K	a	60*35.5*36cm	57*34.5*36cm	防止编带受损	曹佳镇	A/1

ChangZhou Cre-Sound Electronics Co.,Ltd.

Tel: +86-519-86323596; Fax: +86-519-86702455

E-mail:sales5@wj-lianhua.com

	DATE	06-07-2020	SPECIFICATION	ChangZhou Cre-Sound Electronics Co.,Ltd.
	PAGE	3/9		www.cre-soundbuzzer.com
	Rev.	A/1		www.wj-Lianhua.com
<i>MODEL NAME: LPT2270AS-HS-12-4.0-19-R</i>				

Technical Terms:

No.	Technical terms	Value
1	Rated Voltage(Vp-p)	12
2	Max Input Voltage(Vp-p)	30
3	*Rated Current(mA)	≤12
4	Capacitance at 100Hz (pF)	19000 ± 30%
5	*Sound Output at 10cm(dB)	≥95

ChangZhou Cre-Sound Electronics Co.,Ltd.

Tel: +86-519-86323596; Fax: +86-519-86702455

E-mail:sales5@wj-lianhua.com

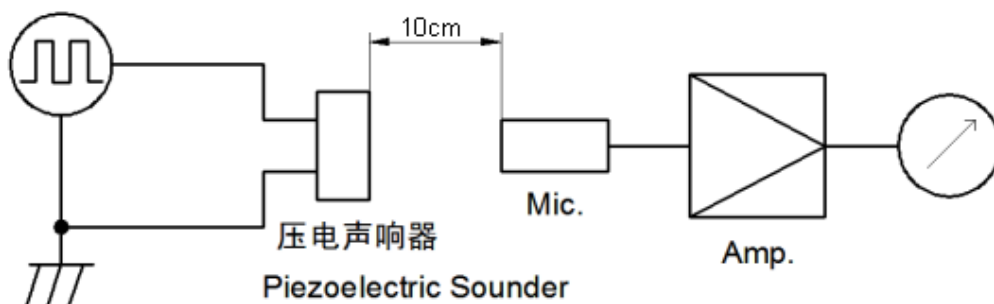

MIC: ND10 普通声级计或等同品
 MIC: ND10 Sound Meter or equivalent

信号发生器: DF1641D或等同品
 Signal Generator: DF1641D or equivalent

Frequency Response:

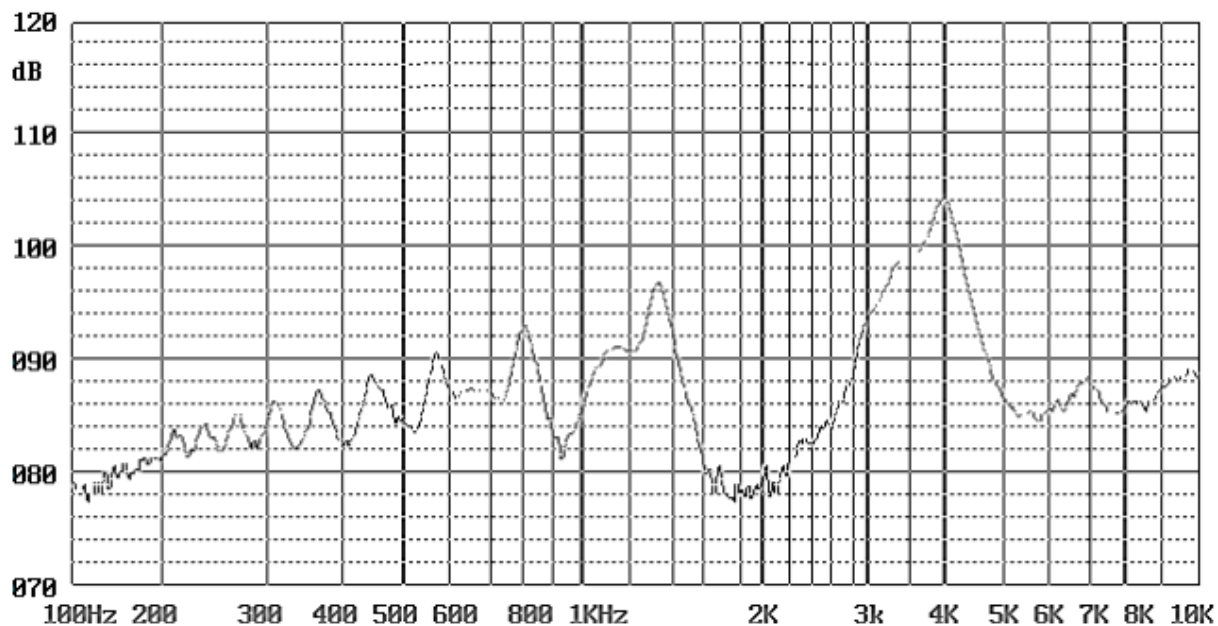

	DATE	06-07-2020	SPECIFICATION	ChangZhou Cre-Sound Electronics Co.,Ltd.
	PAGE	5/9		www.cre-soundbuzzer.com

ChangZhou Cre-Sound Electronics Co.,Ltd.

Tel: +86-519-86323596; Fax: +86-519-86702455

E-mail:sales5@wj-lianhua.com

	Rev.	A/1	www.wj-Lianhua.com
MODEL NAME: LPT2270AS-HS-12-4.0-19-R			

Reliability Test:

NO	ITEM	TESTING CONDITION	VARIANCE AFTER TEST
1	High temp. storage life	The part shall be capable of withstanding a storage temperature is +90°C for 120 hours	After being placed for 2 to 4hrs at room temp, the product shall meet specifications ,except the SPL should be in ±10dB compared with initial one.
2	Low temp. storage life	The part shall be capable of withstanding a storage temperature is -40°C for 120 hours	
3	Temp. Cycle	Total 5 cycles, 1 cycle consisting of -40±2°C, 30 minutes 20±5°C 15 minutes 90±2°C, 30 minutes 20±5°C 15 minutes	
4	Humidity Test	40±2°C, 90~95% RH, 120 hours	
5	Vibration Test	To-and-fro. sweep time (from 10 to 55 Hz and then 55 to 10) under single amplitude of 1.0mm is 1 minute. The vibration test shall consist of 2 hours per plane in each three mutually perpendicular planes for a total time of 6 hours.	The SPL shall meet specification.
6	Shock	Sounder shall be measured after being applied shock (980m/s ²) for each three mutually perpendicular directions to each of 3 times by half sine wave.	After the test, the product shall meet specifications ,except the SPL should be in ±10dB compared with initial one.
7	Drop Test	Dropped naturally from 700mm height onto the surface of 10mm thick wooden board. 2 directions-upper and side of the part are to be applied.	

ChangZhou Cre-Sound Electronics Co.,Ltd.

Tel: +86-519-86323596; Fax: +86-519-86702455

E-mail:sales5@wj-lianhua.com

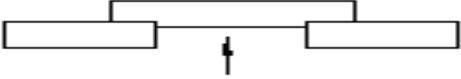
8	Lead pull	<p>The part shall be pushed with a force of 9.8N for 10 ± 1 seconds behind the part.</p> 	After the test part shall meet specifications without any degradation in appearance and performance.
9	Recommended temp. Profile for Reflow Oven	Shown in Fig.1	The SPL shall meet specification.
<p>Warranty: For a period of <u>six months</u> from date of manufacturer under normal operations.</p>			

ChangZhou Cre-Sound Electronics Co.,Ltd.

Tel: +86-519-86323596; Fax: +86-519-86702455

E-mail: sales5@wj-lianhua.com

	DATE	06-07-2020	SPECIFICATION	ChangZhou Cre-Sound Electronics Co.,Ltd.
	PAGE	6/9		www.cre-soundbuzzer.com
	Rev.	A/1		www.wj-Lianhua.com
MODEL NAME: LPT2270AS-HS-12-4.0-19-R				

Recommended Temp. Profile for Reflow Oven (Fig.1)

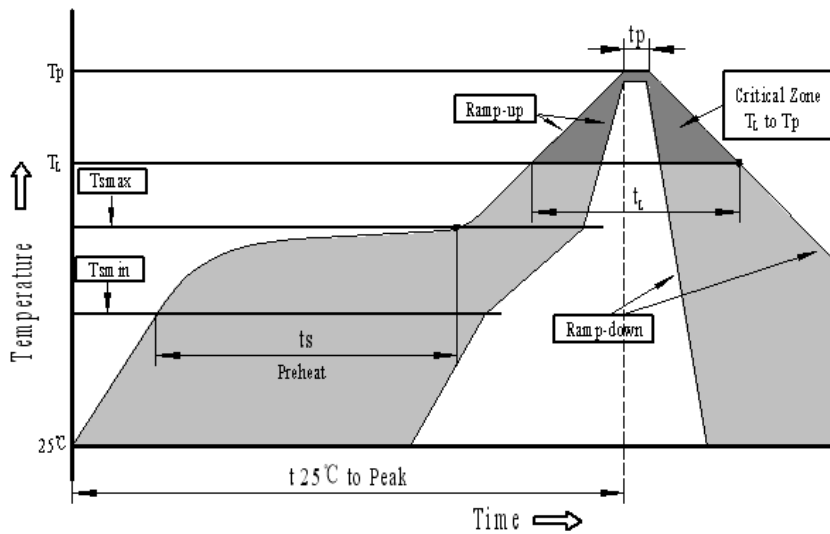

Profile Feature	Pb-Free Assembly
Average ramp-up rate(T_L to T_p)	3°C/second max.
Preheat	
-Temperature Min.(T_{smin})	150°C
-Temperature Min.(T_{smax})	200°C
-Temperature Min.(t_s)	60~180 seconds
T_{smax} to T_L	
-Ramp-up Rate	3°C/second max.
Time maintained above:	
- Temperature(T_L)	217°C

ChangZhou Cre-Sound Electronics Co.,Ltd.

Tel: +86-519-86323596; Fax: +86-519-86702455

E-mail:sales5@wj-lianhua.com

-Time(t_L)	60~150 seconds
Peak temperature(T_p)	245°C+0/-5°C
Time within 5°C of actual Peak temperature (t_p)	6 seconds max.
Ramp-down Rate	6°C/second max.
Time 25°C to Peak Temperature	8 minutes max.

ChangZhou Cre-Sound Electronics Co.,Ltd.

Tel: +86-519-86323596; Fax: +86-519-86702455

E-mail: sales5@wj-lianhua.com

	DATE	06-07-2020	SPECIFICATION	ChangZhou Cre-Sound Electronics Co.,Ltd.
	PAGE	7/9		www.cre-soundbuzzer.com
	Rev.	A/1		www.wj-Lianhua.com
	<i>MODEL NAME: LPT2270AS-HS-12-4.0-19-R</i>			

Packing:

ChangZhou Cre-Sound Electronics Co.,Ltd.

Tel: +86-519-86323596; Fax: +86-519-86702455

E-mail:sales5@wj-lianhua.com

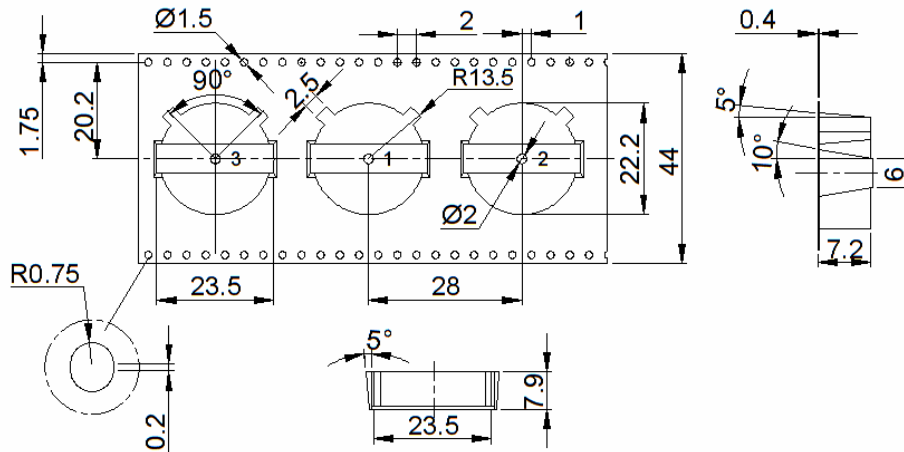

NOTE:

- 1. 10 sprocket hole pitch cumulative tolerance +/-0.2mm.
- 2. All dimensions meet EIA-481-D requirements.
- 3. Thickness: 0.4 +/- 0.05mm.
- 4. Component loaded per 13" reel: 300pcs.

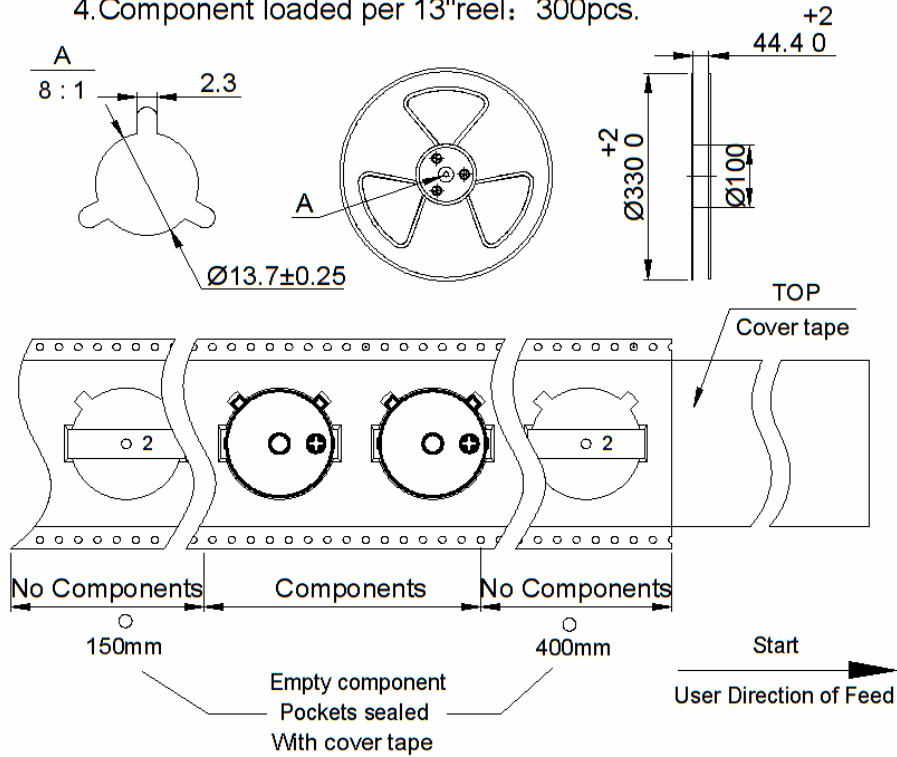

ChangZhou Cre-Sound Electronics Co.,Ltd.

Tel: +86-519-86323596; Fax: +86-519-86702455

E-mail: sales5@wj-lianhua.com

	DATE	06-07-2020	SPECIFICATION	ChangZhou Cre-Sound Electronics Co.,Ltd.
	PAGE	8/9		www.cre-soundbuzzer.com
	Rev.	A/1		www.wj-Lianhua.com
<i>MODEL NAME: LPT2270AS-HS-12-4.0-19-R</i>				

Packing:

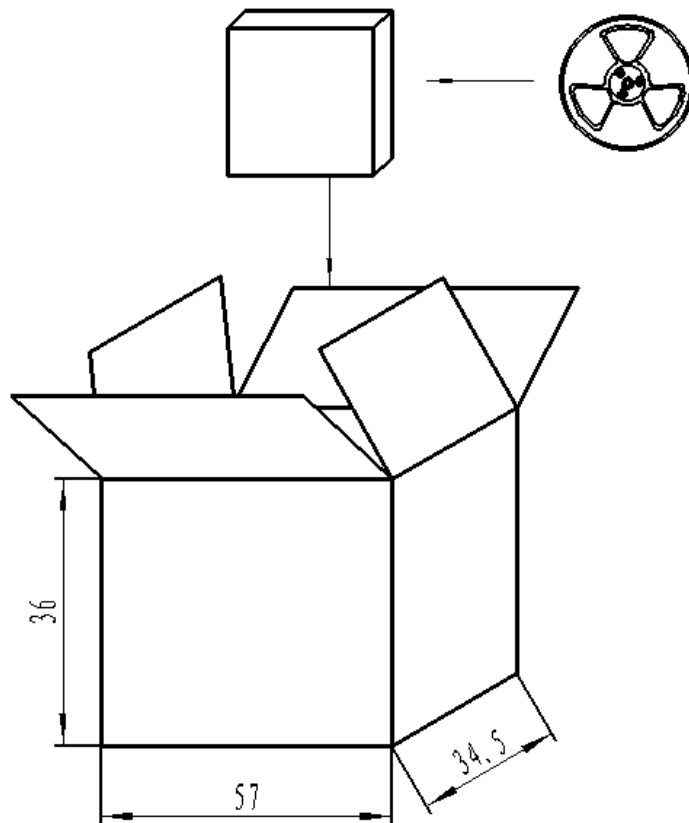

NOTES:

1.300 PCS per box

ChangZhou Cre-Sound Electronics Co.,Ltd.

Tel: +86-519-86323596; Fax: +86-519-86702455

E-mail: sales5@wj-lianhua.com

2.Total 10 boxes per carton

3.Total3000 PCS carton

4.Volum: a 57*34.5*36cm

	DATE	06-07-2020	SPECIFICATION	ChangZhou Cre-Sound Electronics Co.,Ltd.
	PAGE	9/9		www.cre-soundbuzzer.com
	Rev.	A/1		www.wj-Lianhua.com
<i>MODEL NAME: LPT2270AS-HS-12-4.0-19-R</i>				

MSL Rating and Notice

Moisture Sensitivity level and Floor Life

Level	Floor life(out of bag) at factory Ambient $\leq 30^{\circ}\text{C}/60\%\text{RH}$
5a	24 hours

① The products must not be washed.

② Storage Condition:

The products should be stored in the room,where the temperature/humidity is stable.

And avoid such places where there are large temperature changes.

ChangZhou Cre-Sound Electronics Co.,Ltd.

Tel: +86-519-86323596; Fax: +86-519-86702455

E-mail:sales5@wj-lianhua.com

Please store the products at the following conditions:

Temperature:-10 to +40°C Humidity: 15 to 85% R.H.

③ Expire Date on Storage:

Expire date (shelf life) of the products is **six months** after delivered under the conditions of a sealed and an unopened package.

Please use the products with **six months** after delivered.

④ Notice on product Storage:

Please use the products immediately after the package is opened, because the characteristics may be reduced at quality.

ChangZhou Cre-Sound Electronics Co.,Ltd.

Tel: +86-519-86323596; Fax: +86-519-86702455

E-mail:sales5@wj-lianhua.com