

Shenzhen P&O Technology Co.,Limited	Rev No	Issued Date.	Page
	A	2022.3.25	1/12

Project Size.	2.4 inch	
Model No.	P024C117	
Samples No.		
Product type.	240xRGBx320 SPI mode	
Signature by customer:		
Prepared	Checked	Approved

Shenzhen P&O Technology Co.,Limited

Email: polcd@polcd.com

Mobile: 86-136 0019 7172

1.0 GENERAL DESCRIPTION

Item	Specification	Unit
Screen Size	2.4 inch	Diagonal
Number of Pixel	240RGB(H)x320(V)	Pixels
Display area	36.72(H)x48.96(V)	mm
Pixel pitch	51(H)x153(V)	um
Outline Dimension	42.72x60.26x2.30	mm
Pixel arrangement	RGB Vertical Stripe	--
Display mode	Normally White	--
Viewing Direction(eye)	12 O'CLOCK	--
Gray inversion direction	--	
Display Color	262K	--
Luminance(cd/m ²)	260	nit
Contrast Ratio	250:1	--
Surface treatment	--	--
Interface	4W SPI	
Back-light	LED Side-light type	--
Drive IC	ST7789V2	
Operation Temperature	-20~70	°C
Storage Temperature	-30~80	°C
Weight	--	g

1.1 Features

- n 4W SPI interface.

1.2 Applications

- n MPOS Device.
- n Personal Navigation Device.
- n Other devices which require high quality displays.

2.0 INPUT INTERFACE PIN ASSIGNMENT

FPC connector is used for electronics interface.

PinNo.	Symbol	Function
1	GND	Ground
2	RESET	External reset input.
3	SCK	Serial interface clock
4	RS	Display data/command selection pin in parallel
5	CS	Chip select input pin
6	SDA	SPI interface input/output pin
7	SD0	SPI interface output pin
8	GND	Ground
9	VCC	Power Supply. 2.8V
10	BL_A	LED back light(Anode)
11-14	BL_K	LED back light(Cathode)
15	XL	Touch the left line
16	YU	Touch the upper circuit
17	XR	Touch the right end line
18	YD	Touch the lower line

3.0 OPTICAL CHARACTERISTICS

3.1 Optical specification

Item	Symbol	Condition	Min	Type	Max	Unit	Note
White luminance (Center)	Lv	$\Theta=0$ Normal Viewing Angle $I_{BL}=80mA$	--	260	--	cd/m ²	(4)(5)(7)
Response time	Tr+Tf		--	30	--	ms	(3)
Contrast ratio	CR		--	250	--	--	(2)(4)
Color Chromaticity (CIE1931)	white		Wx	0.288	0.308	0.328	
		Wy	0.305	0.325	0.345		
Viewing Angle	Hor	Θ_L	--	45	--		(1)
		Θ_R	--	45	--		
	Ver	Θ_U	--	45	--		
		Θ_D	--	20	--		
Brightness uniformity	Avg	$\Theta=0$	80	90	--	%	(5)
Color Gamut	NTSC	$\Theta=0$	--	56	--	%	(6)
Optima View Direction	12 O'CLOCK						(1)

3.2 Measuring Condition

- n Measuring surrounding: dark room
- n LED current IL: 80mA
- n Ambient temperature: $25 \pm 2^\circ C$
- n 15min. warm-up time

3.3 Measuring Equipment

- n BM-7
- n Measuring spot size: 20 ~ 21 mm

Rev No	Issued Date.	Page
A	2022.3.25	5/12

Note (1) Definition of Viewing Angle

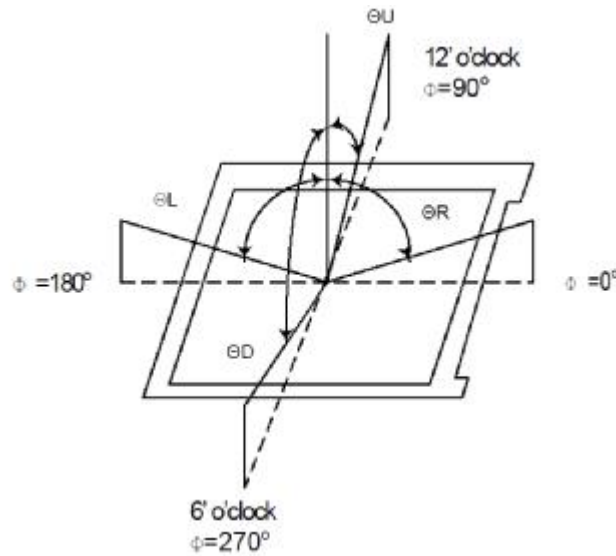

Note (2) Definition of Contrast Ratio(CR):

Measured at the center point of panel

$$CR = \frac{\text{Luminance with all pixels white}}{\text{Luminance with all pixels black}}$$

Note (3) Definition of Response Time: Sum of TR and TF

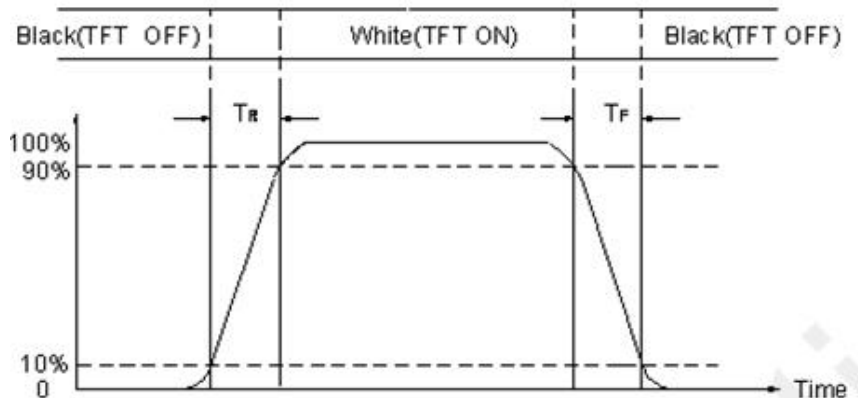

Note (4) Definition of optical measurement setup

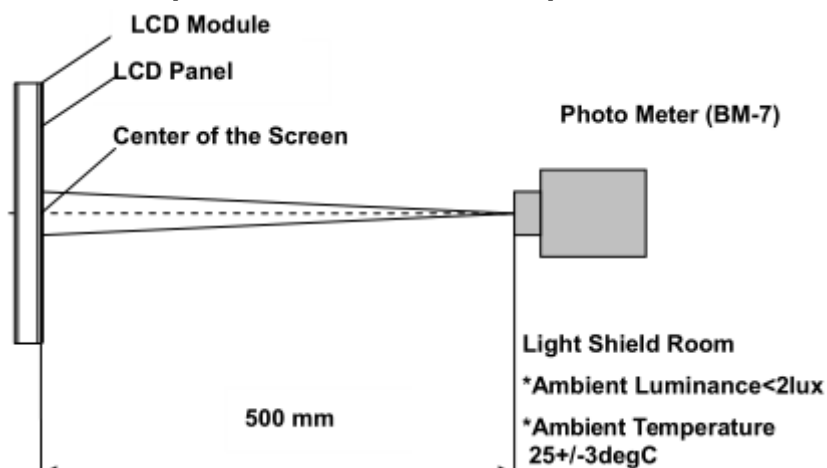

Note (5) Definition of brightness uniformity

The luminance uniformity is calculated by using following formula.

$$\Delta B_p = B_p (\text{Min.}) / B_p (\text{Max.}) \times 100 (\%)$$

$B_p (\text{Max.})$ = Maximum brightness in 9 measured spots

$B_p (\text{Min.})$ = Minimum brightness in 9 measured spots .

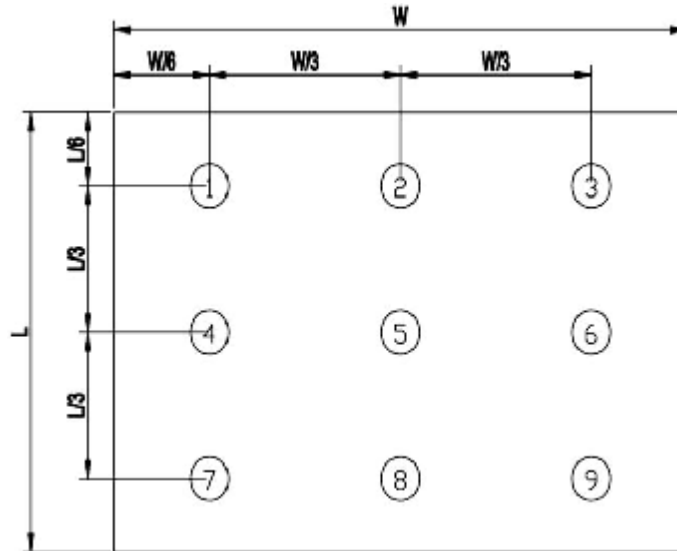

Note (6) Definition of Color of CIE1931 Coordinate and NTSC Ratio.

Color gamut:

$$S = \frac{\text{Area of RGB triangle}}{\text{Area of NTSC triangle}} \times 100\%$$

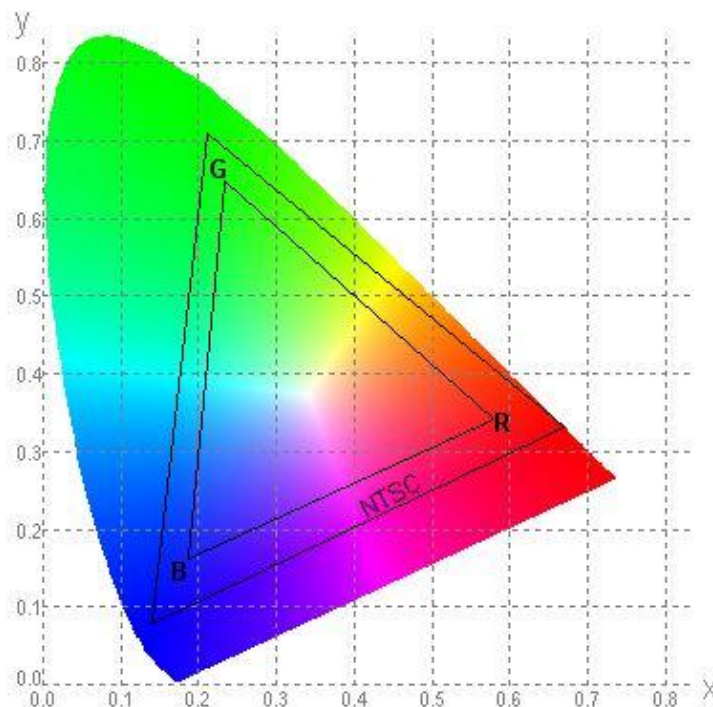

Note (7) Measured the luminance of white state at center point.

4.0 ELECTRICAL CHARACTERISTICS

4.1 TFT LCD Module

Item	Symbol	Min.	Typ.	Max.	Unit	Remark
Analog supply voltage	VDD	2.4	2.8	3.3	V	
Digital supply voltage	VDDI	1.65	1.8	3.3		
Input signal Voltage	VIH	0.7VDDI	-	VDDI	V	
	VIL	GND	-	0.3VDDI	V	

4.2 Back-Light Unit

The backlight system is an edge-lighting type with 4 LED Dies.

The characteristics of the LED are shown in the following tables.

Item	Symbol	Min	Typ	Max	Unit	Note
LED current	IL	-	60	80	mA	(2)
LED voltage	VL	-	2.8	3.2	V	
Operating LED life time	Hr	-	4500	5000	Hour	(1)(2)

Note (1) LED life time (Hr) can be defined as the time in which it continues to operate under the condition: $T_a=25\pm 3\text{ }^{\circ}\text{C}$, typical IL value indicated in the above table until the brightness becomes less than 50%.

Note (2) The "LED life time" is defined as the module brightness decrease to 50% original brightness at $T_a=25^{\circ}\text{C}$ and $IL=80\text{mA}$. The LED lifetime could be decreased if operating IL is larger than 100mA. The constant current driving method is suggested.

5.0 Reliability conditions

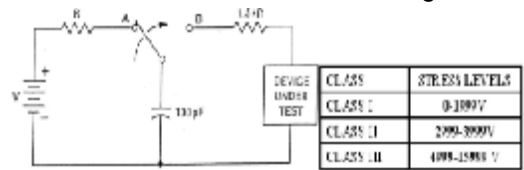
NO	Item	Conditions	Notes
1	High Temperature Storage	Ta=80°C ± 2°C, 72hrs	
2	Low Temperature Storage	Ta=-30°C ± 2°C, 72hrs	
3	High Temperature Operation	Ta=70°C ± 2°C, 72hrs(Operation state)	
4	Low Temperature Operation	Ta=-20°C ± 2°C, 72hrs(Operation state)	
5	High Temperature and High Humidity (Storage)	Ta=+60°C, 90%RH, 72hrs	
6	Thermal Cycling Test (non operation)	-20°C (30min) → +70°C (30min), 10cycles	
7	Electro static Discharge	Human Body Mode 100pF ± 10%/1500 Ω ± 1% Air ± 8kV / contact ± 6kV Consecutive 10times/ Each discharge 	
8	Vibration test(with carton)	Total fixed amplitude:15mm Vibration Frequency :10~55Hz One cycle 60 seconds to 3 directions of X,Y,Z for Each 15 minutes	
9	Drop (with carton)	Height: 60cm 1 corner, 3 edges, 6 surfaces	

Note: There is no display function NG issue occurred, all the cosmetic specification is judged before the reliability stress.

6.0 OUTLINE DIMENSION

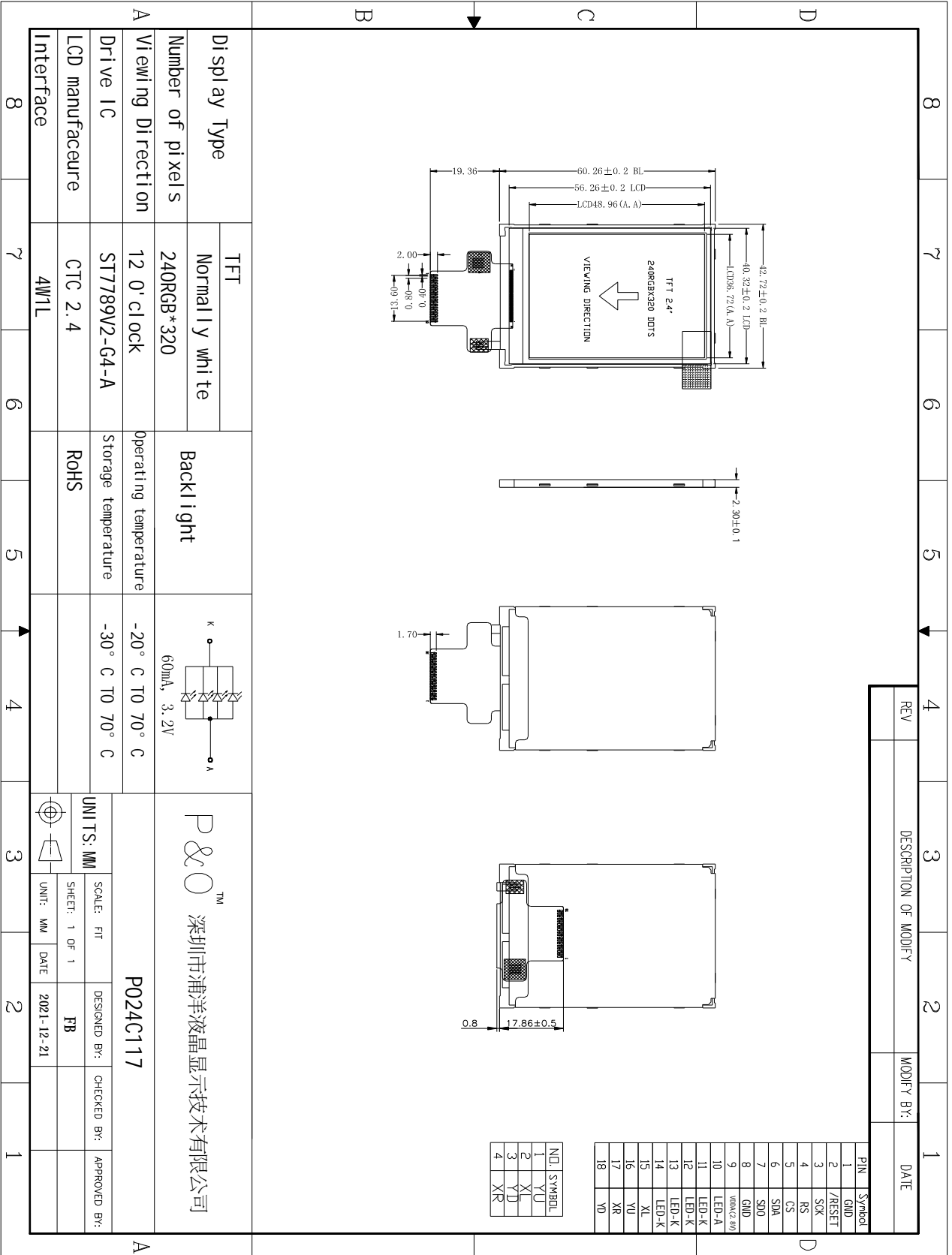

7.0 Items and Criteria:

7.1 Guarantee

APEX warrants the quality of our products for **1 year** (from the date of delivery). If there are functional defects found during the period of warranty, the defective products would be replaced on a one-to-one basis. Apex would not be responsible for any direct /indirect liabilities consequential to any parties.

All the products should be stored or used as specified conditions described in these sheets. If module productions are not stored or used as specified conditions, herein, it will be void the **1 year** warranty(guarantee).

7.2 Visual inspection criterion in cosmetic

(1) Glass defect

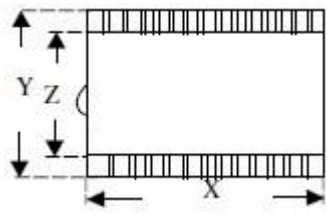
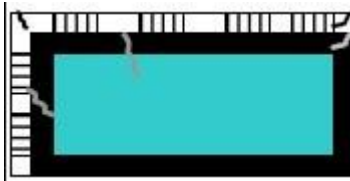
Glass defect			
NO	Defect	Criteria	Remark
1	Dimension(Minor)	By engineering diagram	
2	Cracks(Major)	Extensive crack 【Reject】	

(2) LCM appearance defect

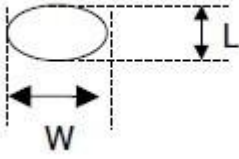
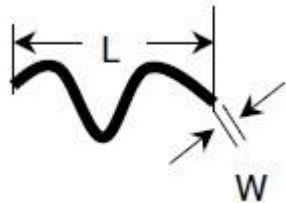
NO	Defect	Criteria		Remark
1	Round type(Minor)	Spec	Permissible Qty	1. $\psi = (L+W)/2$, L: Length, W: Width 2. Disregard if out of A.A. 
		$\psi \leq 0.10\text{mm}$	Disregard	
		$0.10\text{mm} < \psi \leq 0.20\text{mm}$	3	
		$0.20\text{mm} < \psi$	0	
2	Line type(Minor)	Spec	Permissible Qty	1. L: Length, W: Width 2. Disregard if out of A.A. 
		$W \leq 0.03\text{mm}$	Disregard	
		$L \leq 3.0\text{mm}$ and $0.03\text{mm} < W \leq 0.05\text{mm}$	2	
		$L \leq 3.0\text{mm}$ and $0.05\text{mm} < W \leq 0.10\text{mm}$	1	
		$W > 0.10\text{mm}$ or $L > 3.0\text{mm}$	0	
3	Polarizer dent(Minor)	Spec.	Permissible Qty	1. $\psi = (L+W)/2$, L: Length, W: Width 2. Disregard if out of A.A.
		$\psi \leq 0.20\text{mm}$	Disregard	
		$0.20\text{mm} < \psi \leq 0.30\text{mm}$	2	
		$0.30\text{mm} < \psi \leq 0.50\text{mm}$	1	

Shenzhen P&O Technology Co., Limited	Rev No	Issued Date.	Page
	A	2022.3.25	11/12

(3) FPC

NO	Defect	Criteria	Remark
1	Copper peeling(Minor)	Copper peeling 【Reject】	
2	Golden finger	FPC golden finger broken, dead fold, indentation makes FPC surface broken 【Reject】 Tin plating layer(or gold plating) scratch, but not hurt circuit 【Accept】 Except circuit, other position scratch but not expose metal wire 【Accept】	
3	Pin	FPC PI layer delamination 【Reject】 Material and color are inconsistent with sample, FPC burrs 【Reject】 FPC Pin deformation but not affect function. 【Accept】 FPC Pin area is dirty 【Reject】 Other than FPC Pin area is dirty but not affect function 【Accept】	
4	Golden finger	Golden finger edge has burrs,foreign material 【Reject】 Golden finger oxidation (dark), uneven electroplating, pinhole, foreign material 【Reject】 Golden finger soldering pad crack exceeds 1/3 length of soldering pad, and soldering pad crack exceed 2 Pins 【Reject】 Golden finger tin plating(or gold plating)scratch, but not hurt circuit 【Accept】 Other than golden finger area scratch but not expose metal circuit 【Accept】	
5	FPC Silk printing	Ghosting, incomplete silk printing, wrong printing 【Reject】	
6	FPC Circuit line width	Line width deviation exceed 1/3 line width 【Reject】	



(4) Black tape

NO	Defect	Criteria	Remark
1	Shift(Minor)	IC exposed 【Reject】	
2	No black tape(Minor)	No black tape 【Reject】	

(5) Silicon

NO	Defect	Criteria	Remark
1	Amount of silicon (Minor)	ITO exposed 【Reject】	

7.3 Visual inspection criterion in electrical display

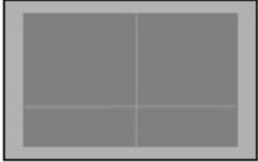
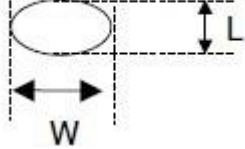
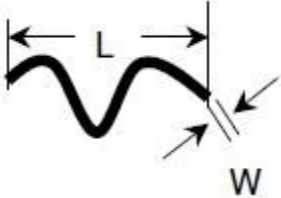
NO	Defect	Criteria		Remark
1	No display (Major)	Not allowed		
2	Missing line (Major)	Not allowed		
3	Darker or lighter Line (Major)	Not allowed		
4	Weak line(Major)	By limited sample		
5	Bright / Dark point (Minor)	Spec.	Permissible Qty	1:1sub-pixel: 1R or 1G or1B 2:Point defect area $\geq 1/2$ sub pixel.
		Bright point	1	
		Dark point	2	
6	Round type (Minor)	Spec	Permissible Qty	1. $\psi=(L+W)/2$, L: Length, W: Width 2. Disregard if out of A.A. 
		$\psi \leq 0.10\text{mm}$	Disregard	
		$0.10\text{mm} < \psi \leq 0.20\text{mm}$	3	
		$0.20\text{mm} < \psi$	0	
7	Line type (Minor)	Spec.	Permissible Qty	1. L: Length, W: Width 2. Disregard if out of A.A. 
		$W \leq 0.03\text{mm}$	Disregard	
		$L \leq 3.0\text{mm}$ and $0.03\text{mm} < W \leq 0.05\text{mm}$	2	
		$L \leq 3.0\text{mm}$ and $0.05\text{mm} < W \leq 0.10\text{mm}$	1	
		$W > 0.10\text{mm}$ or $L > 3.0\text{mm}$	0	
8	Mura (Minor)	By 5% ND filter invisible		