



1. Scope

This specification defines the electrical and mechanical characteristics of the product.

2. General Specification

| No. | Item                                   | Specification  | Unit               |
|-----|--|----------------|--------------------|
| 1   | Rated Voltage                          | 12             | VDC                |
| 2   | Operating Voltage                      | 6.0~13.8       | VDC                |
| 3   | Input Current                          | 0.16(Max.0.19) | A                  |
| 4   | Label Current                          | 0.16           | A                  |
| 5   | Input Power                            | 1.92(Max.2.30) | W                  |
| 6   | Speed                                  | 5500 ± 10%     | RPM                |
| 7   | Max. Air Flow(At Zero Static Pressure) | 14.3(Min.12.8) | CFM                |
| 8   | Max. Air Pressure(At Zero Air Flow)    | 4.3(Min.3.5)   | mmH <sub>2</sub> O |
| 9   | Acoustical Noise                       | 32(Max.35)     | dB(A)              |

3. Electrical characteristics

|   |                       |  |
|---|-----------------------|--|
| 1 | Insulation resistance | Min 10M ohm between frame and positive terminal at 500VDC.   |
| 2 | Dielectric strength   | Max 5 mA between frame and positive terminal at 500VAC 1 min or 600VAC 1Sec.   |
| 3 | Life Expectancy       | Average life is about 30000 hours while fan is operating at rated voltage in room temperature 25°C and relative Humidity 15%~65%RH environment.  |
| 4 | Insulated Class       | UL: Class A (105°C)  |
| 5 | Safety Approvals      | ZP    |

4. Mechanical Characteristics

|   |                           |                               |
|---|---------------------------|-------------------------------|
| 1 | Dimension                 | See Dimension Drawing         |
| 2 | frame                     | Thermoplastic ,Black ,UL94V-0 |
| 3 | Impeller                  | Thermoplastic ,Black ,UL94V-0 |
| 4 | Bearing                   | 含油轴承 Sleeve Bearing           |
| 5 | Weight                    | Approx. 31g                   |
| 6 | Ingress Protection Rating | N/A                           |

5. Environmental

|   |                       |   |
|---|-----------------------|---|
| 1 | Operating Temperature | -10 ~ +70 °C  |
| 2 | Storage Temperature   | -40 ~ +75 °C  |
| 3 | Operating Humidity    | 35% ~ 85%RH   |
| 4 | Storage Humidity      | 35% ~ 85%RH   |
| 5 | RoHS Compliance       | Hazardous substances contents in our products is in compliance with RoHS (EU) 2015/863 requirement. |

6. Protection

|   |                         |  |
|---|-------------------------|--|
| 1 | Polarity Protection     | Be capable of withstanding 10 minutes will not cause damage if reverse connection for positive and negative leads.                       |
| 2 | Locked Rotor Protection | Impedance of motor winding protects motor from damage in 72 hours of locking rotor condition at rated voltage and operation temperature. |

7. Acoustical Noise

Fan is hanged in anechoic chamber, noise is measured at rated voltage in free air in anechoic chamber with microphone at a distance of one meter from the air intake .

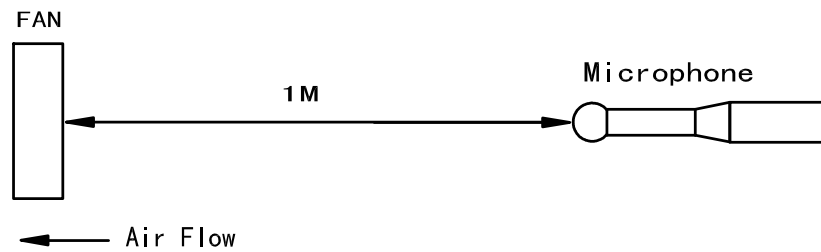

8. Performance Curve

At operation voltage in room temperature and 65% humidity

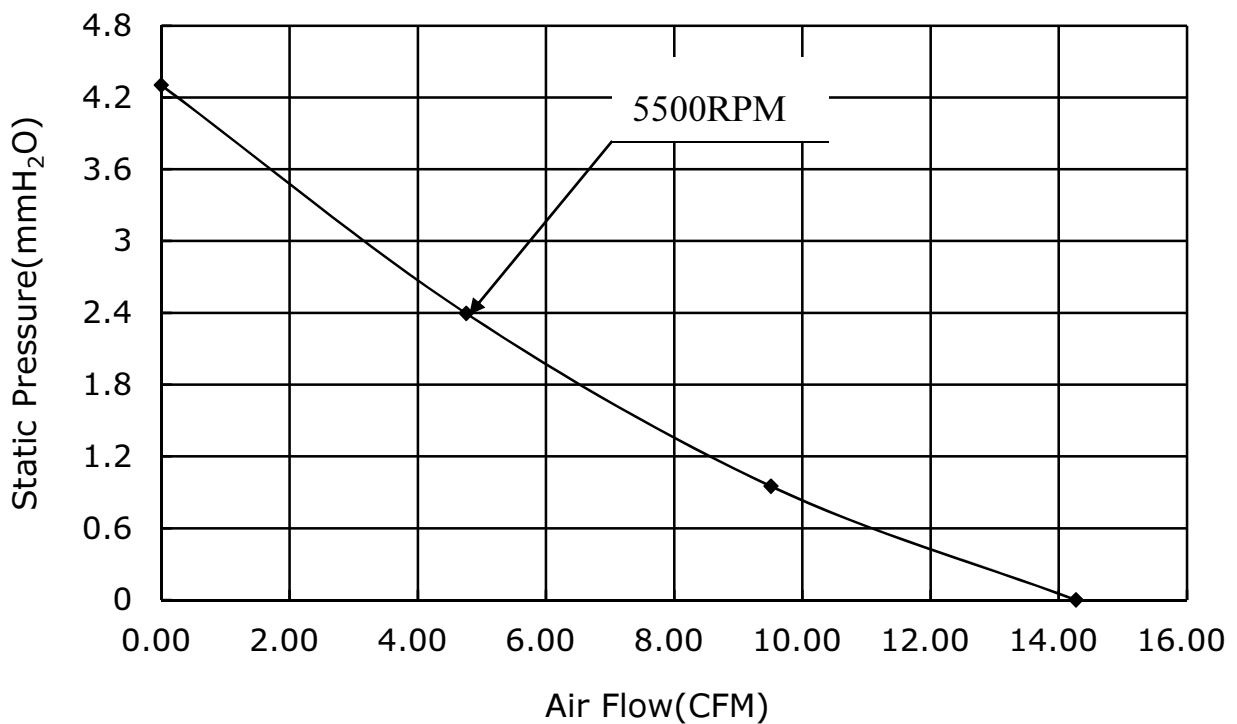

9. Label

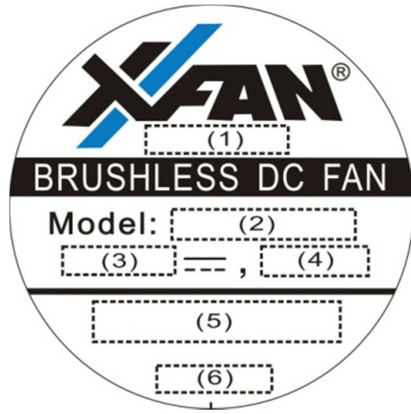

|     |                  |
|-----|------------------|
| (1) | Date Code        |
| (2) | Model No.        |
| (3) | Voltage          |
| (4) | Current          |
| (5) | Safety Approvals |
| (6) | Location         |

10. Dimension Drawing

Unit: mm

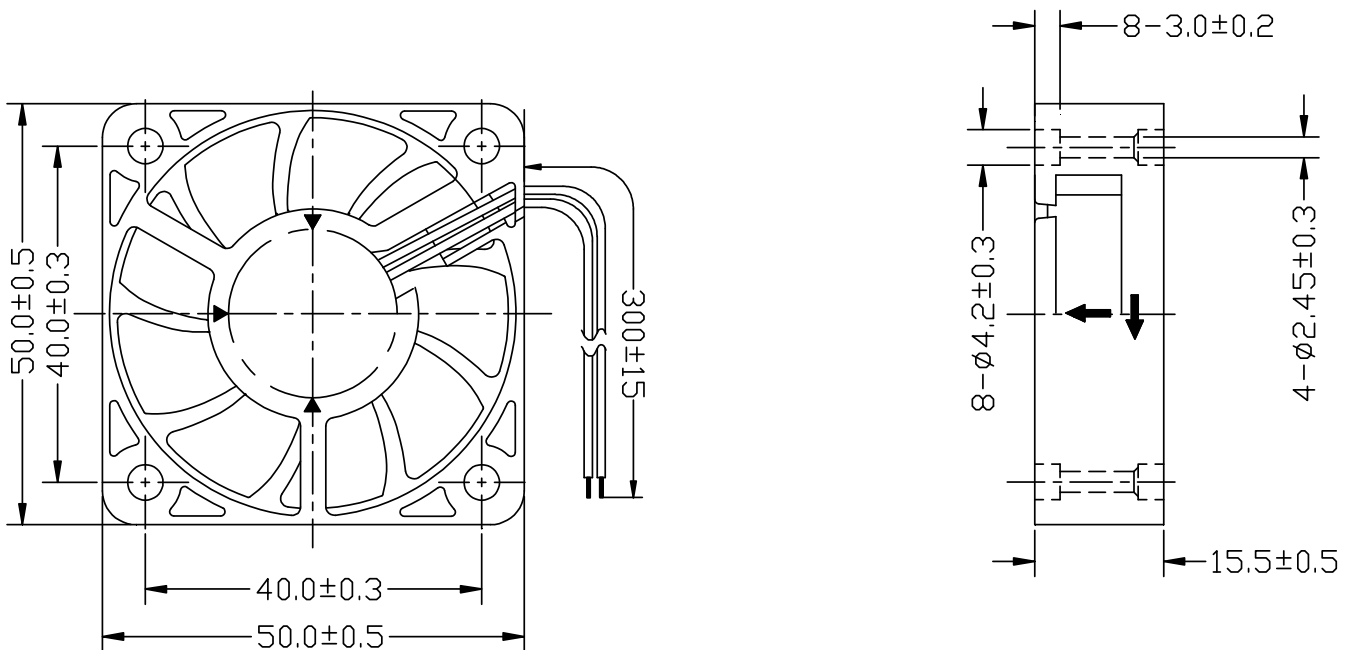

Lead Wire :UL1007, 24AWG; Red Positive(+); Black Negative(-)

| No. | Qty | Part Name | Description |
|-----|-----|-----------|-------------|
| ①   | 1   | Label     |             |

## NOTES

1. We provide products should be used within the specification appointed condition, so we will not guarantee this product quality if your application exceeds the limitations outlined in this specification.
2. Unless prior agreement, we reserves the right to use components with equivalent specifications from multiple sources, so material and construction are subject to change without advance notice. this changes should be within this specification here above.
3. Product will be shipped in accordance with this specification unless we has been previously notified of parameters requiring exception, if parameters which are not specified in this specification will be identical to the final sample which has been approved by your company.
4. Unless otherwise specified, marking measurement and tests are on room temperature, power supply provide rated voltage tolerance must not over  $\pm 0.1\text{VDC}$ .
5. Except some special designs, During use against caused by dust, water, droplets, dew, corrosive fluids, application bugs, etc. accidents cause product performance degradation, safety problem even product failures.
6. The impeller and the motor are combined to maintain good balance before this product leave factory, Do not separate the impeller from the motor when you use. This may cause vibration and decrease the operation life.
7. Do not put your finger or any other part of your body in to this product when the fan in running, You may get injured, never put an object into the fan, it may damage the fan.
8. Always observe the operating conditions and the environmental requirements indicated in this catalog (such as operating voltage range, operation temperature range, and power connection points) when operation the product.
9. Please handle and install this product carefully, Hitting or dropping or extruding with fingers or other objects this product may damage holders or bearings. Resulting in strange noise and vibration during equipment operation.
10. Make sure to turn off the power before connection or disconnecting the connectors. This may cause short of electronic parts.
11. Improper mounting may cause harsh resonance, vibration, and noise. Please mount securely.
12. Always ensure that products are stored according to the storage temperatures and humidity specified. Do not store in such as high temperature and high humidity and where there is corrosive gas environment, If the products are stored for more than 6 months, we recommend functional testing before using.