

# MC78L00A Series, NCV78L00A

## 100 mA Positive Voltage Regulators

The MC78L00A Series of positive voltage regulators are inexpensive, easy-to-use devices suitable for a multitude of applications that require a regulated supply of up to 100 mA. Like their higher powered MC7800 and MC78M00 Series cousins, these regulators feature internal current limiting and thermal shutdown making them remarkably rugged. No external components are required with the MC78L00 devices in many applications.

These devices offer a substantial performance advantage over the traditional zener diode-resistor combination, as output impedance and quiescent current are substantially reduced.

### Features

- Wide Range of Available, Fixed Output Voltages
- Low Cost
- Internal Short Circuit Current Limiting
- Internal Thermal Overload Protection
- No External Components Required
- Complementary Negative Regulators Offered (MC79L00A Series)
- NCV Prefix for Automotive and Other Applications Requiring Unique Site and Control Change Requirements; AEC-Q100 Qualified and PPAP Capable
- These are Pb-Free Devices

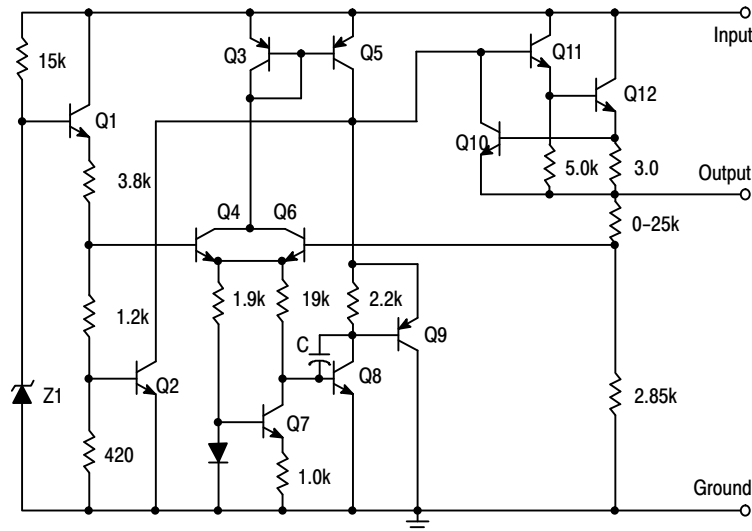
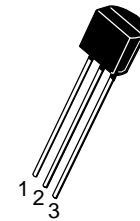

Figure 1. Representative Schematic Diagram



ON Semiconductor®

[www.onsemi.com](http://www.onsemi.com)



STRAIGHT LEAD  
BULK PACK

TO-92  
P SUFFIX  
CASE 029

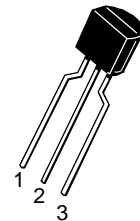

BENT LEAD  
TAPE & REEL  
AMMO PACK

Pin: 1. Output  
2. Ground  
3. Input



SOIC-8\*  
D SUFFIX  
CASE 751



SOT-89  
CASE 528AG

\*SOIC-8 is an internally modified SO-8 package. Pins 2, 3, 6, and 7 are electrically common to the die attach flag. This internal lead frame modification decreases package thermal resistance and increases power dissipation capability when appropriately mounted on a printed circuit board. SOIC-8 conforms to all external dimensions of the standard SO-8 package.

### PIN CONNECTIONS

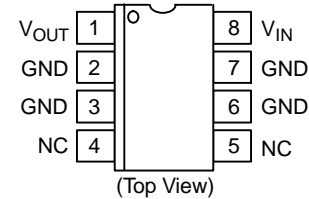

(Top View)

(TAB)



(Top View)

### ORDERING INFORMATION

See detailed ordering and shipping information in the package dimensions section on page 9 of this data sheet.

### DEVICE MARKING INFORMATION

See general marking information in the device marking section on page 12 of this data sheet.

## MC78L00A Series, NCV78L00A

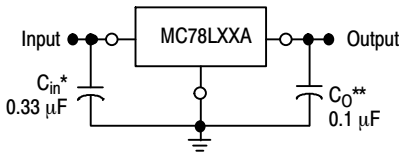

Figure 2. Standard Application

A common ground is required between the input and the output voltages. The input voltage must remain typically 2.0 V above the output voltage even during the low point on the input ripple voltage.

\*  $C_{in}$  is required if regulator is located an appreciable distance from power supply filter.

\*\*  $C_O$  is not needed for stability; however, it does improve transient response.

### ABSOLUTE MAXIMUM RATINGS

| Rating   | Symbol      | Value          | Unit |
|--|-------------|----------------|------|
| Input Voltage (5.0 V–9.0 V)<br>(12 V–18 V)<br>(24 V) | $V_I$       | 30<br>35<br>40 | Vdc  |
| Storage Temperature Range                            | $T_{stg}$   | -65 to +150    | °C   |
| Maximum Junction Temperature                         | $T_J$       | 150            | °C   |
| Moisture Sensitivity Level                           | MSL         | 1              | –    |
| ESD Capability, Human Body Model (Note 1)            | $ESD_{HBM}$ | 2000           | V    |
| ESD Capability, Machine Model (Note 1)               | $ESD_{MM}$  | 200            | V    |
| ESD Capability, Charged Device Model (Note 1)        | $ESD_{CDM}$ | 2000           | V    |

Stresses exceeding those listed in the Maximum Ratings table may damage the device. If any of these limits are exceeded, device functionality should not be assumed, damage may occur and reliability may be affected.

1. This device series incorporates ESD protection and is tested by the following methods:

ESD Human Body Model tested per AEC-Q100-002 (EIA/JESD22-A114)

ESD Machine Model tested per AEC-Q100-003 (EIA/JESD22-A115)

ESD Charged Device Model tested per EIA/JES D22/C101, Field Induced Charge Model.

### THERMAL CHARACTERISTICS

| Rating   | Symbol          | Value              | Unit |
|--|-----------------|--------------------|------|
| Package Dissipation  | PD              | Internally Limited | W    |
| Thermal Characteristics, TO-92<br>Thermal Resistance, Junction-to-Ambient  | $R_{\theta JA}$ | 200                | °C/W |
| Thermal Characteristics, SOIC8<br>Thermal Resistance, Junction-to-Ambient  | $R_{\theta JA}$ | Refer to Figure 8  | °C/W |
| Thermal Characteristics, SOT-89<br>Thermal Resistance, Junction-to-Ambient | $R_{\theta JA}$ | 55                 | °C/W |

2. Thermal Resistance, Junction-to-Ambient depends on P.C.B. Copper area. See details in Figure 8.

**Thermal Resistance, Junction-to-Case** is not defined. SOIC 8 lead and TO-92 packages that do not have a heat sink like other packages may have. This is the reason that a  $\theta_{JC}$  is never specified. A little heat transfer will occur through the package but since it is plastic, it is minimal. The majority of the heat that is transferred is through the leads where they connect to the circuit board.

## MC78L00A Series, NCV78L00A

**ELECTRICAL CHARACTERISTICS** ( $V_I = 10\text{ V}$ ,  $I_O = 40\text{ mA}$ ,  $C_I = 0.33\text{ }\mu\text{F}$ ,  $C_O = 0.1\text{ }\mu\text{F}$ ,  $-40^\circ\text{C} < T_J < +125^\circ\text{C}$  (for MC78LXXAB, NCV78L05A),  $0^\circ\text{C} < T_J < +125^\circ\text{C}$  (for MC78LXXAC), unless otherwise noted.)

| Characteristics   | Symbol                     | MC78L05AC, AB, NCV78L05A |           |              | Unit          |
|---|----------------------------|--------------------------|-----------|--------------|---------------|
|   |                            | Min                      | Typ       | Max          |               |
| Output Voltage ( $T_J = +25^\circ\text{C}$ )  | $V_O$                      | 4.8                      | 5.0       | 5.2          | Vdc           |
| Line Regulation<br>( $T_J = +25^\circ\text{C}$ , $I_O = 40\text{ mA}$ )<br>$7.0\text{ Vdc} \leq V_I \leq 20\text{ Vdc}$<br>$8.0\text{ Vdc} \leq V_I \leq 20\text{ Vdc}$                 | $\text{Reg}_{\text{line}}$ | –<br>–                   | 55<br>45  | 150<br>100   | mV            |
| Load Regulation<br>( $T_J = +25^\circ\text{C}$ , $1.0\text{ mA} \leq I_O \leq 100\text{ mA}$ )<br>( $T_J = +25^\circ\text{C}$ , $1.0\text{ mA} \leq I_O \leq 40\text{ mA}$ )            | $\text{Reg}_{\text{load}}$ | –<br>–                   | 11<br>5.0 | 60<br>30     | mV            |
| Output Voltage<br>( $7.0\text{ Vdc} \leq V_I \leq 20\text{ Vdc}$ , $1.0\text{ mA} \leq I_O \leq 40\text{ mA}$ )<br>( $V_I = 10\text{ V}$ , $1.0\text{ mA} \leq I_O \leq 70\text{ mA}$ ) | $V_O$                      | 4.75<br>4.75             | –<br>–    | 5.25<br>5.25 | Vdc           |
| Input Bias Current<br>( $T_J = +25^\circ\text{C}$ )<br>( $T_J = +125^\circ\text{C}$ )   | $I_{\text{IB}}$            | –<br>–                   | 3.8<br>–  | 6.0<br>5.5   | mA            |
| Input Bias Current Change<br>( $8.0\text{ Vdc} \leq V_I \leq 20\text{ Vdc}$ )<br>( $1.0\text{ mA} \leq I_O \leq 40\text{ mA}$ )   | $\Delta I_{\text{IB}}$     | –<br>–                   | –<br>–    | 1.5<br>0.1   | mA            |
| Output Noise Voltage<br>( $T_A = +25^\circ\text{C}$ , $10\text{ Hz} \leq f \leq 100\text{ kHz}$ )   | $V_n$                      | –                        | 40        | –            | $\mu\text{V}$ |
| Ripple Rejection ( $I_O = 40\text{ mA}$ ,<br>$f = 120\text{ Hz}$ , $8.0\text{ Vdc} \leq V_I \leq 18\text{ V}$ , $T_J = +25^\circ\text{C}$ )   | RR                         | 41                       | 49        | –            | dB            |
| Dropout Voltage ( $T_J = +25^\circ\text{C}$ )   | $V_I - V_O$                | –                        | 1.7       | –            | Vdc           |

NOTE: NCV78L05A:  $T_{\text{low}} = -40^\circ\text{C}$ ,  $T_{\text{high}} = +125^\circ\text{C}$ . Guaranteed by design. NCV prefix is for automotive and other applications requiring site and change control.

**ELECTRICAL CHARACTERISTICS** ( $V_I = 14\text{ V}$ ,  $I_O = 40\text{ mA}$ ,  $C_I = 0.33\text{ }\mu\text{F}$ ,  $C_O = 0.1\text{ }\mu\text{F}$ ,  $-40^\circ\text{C} < T_J < +125^\circ\text{C}$  (for MC78LXXAB),  $0^\circ\text{C} < T_J < +125^\circ\text{C}$  (for MC78LXXAC), unless otherwise noted.)

| Characteristics  | Symbol                     | MC78L08AC, AB |           |            | Unit          |
|--|----------------------------|---------------|-----------|------------|---------------|
|  |                            | Min           | Typ       | Max        |               |
| Output Voltage ( $T_J = +25^\circ\text{C}$ )   | $V_O$                      | 7.7           | 8.0       | 8.3        | Vdc           |
| Line Regulation<br>( $T_J = +25^\circ\text{C}$ , $I_O = 40\text{ mA}$ )<br>$10.5\text{ Vdc} \leq V_I \leq 23\text{ Vdc}$<br>$11\text{ Vdc} \leq V_I \leq 23\text{ Vdc}$                  | $\text{Reg}_{\text{line}}$ | –<br>–        | 20<br>12  | 175<br>125 | mV            |
| Load Regulation<br>( $T_J = +25^\circ\text{C}$ , $1.0\text{ mA} \leq I_O \leq 100\text{ mA}$ )<br>( $T_J = +25^\circ\text{C}$ , $1.0\text{ mA} \leq I_O \leq 40\text{ mA}$ )             | $\text{Reg}_{\text{load}}$ | –<br>–        | 15<br>8.0 | 80<br>40   | mV            |
| Output Voltage<br>( $10.5\text{ Vdc} \leq V_I \leq 23\text{ Vdc}$ , $1.0\text{ mA} \leq I_O \leq 40\text{ mA}$ )<br>( $V_I = 14\text{ V}$ , $1.0\text{ mA} \leq I_O \leq 70\text{ mA}$ ) | $V_O$                      | 7.6<br>7.6    | –<br>–    | 8.4<br>8.4 | Vdc           |
| Input Bias Current<br>( $T_J = +25^\circ\text{C}$ )<br>( $T_J = +125^\circ\text{C}$ )  | $I_{\text{IB}}$            | –<br>–        | 3.0<br>–  | 6.0<br>5.5 | mA            |
| Input Bias Current Change<br>( $11\text{ Vdc} \leq V_I \leq 23\text{ Vdc}$ )<br>( $1.0\text{ mA} \leq I_O \leq 40\text{ mA}$ )   | $\Delta I_{\text{IB}}$     | –<br>–        | –<br>–    | 1.5<br>0.1 | mA            |
| Output Noise Voltage<br>( $T_A = +25^\circ\text{C}$ , $10\text{ Hz} \leq f \leq 100\text{ kHz}$ )  | $V_n$                      | –             | 60        | –          | $\mu\text{V}$ |
| Ripple Rejection ( $I_O = 40\text{ mA}$ ,<br>$f = 120\text{ Hz}$ , $12\text{ V} \leq V_I \leq 23\text{ V}$ , $T_J = +25^\circ\text{C}$ )   | RR                         | 37            | 57        | –          | dB            |
| Dropout Voltage ( $T_J = +25^\circ\text{C}$ )  | $V_I - V_O$                | –             | 1.7       | –          | Vdc           |

## MC78L00A Series, NCV78L00A

**ELECTRICAL CHARACTERISTICS** ( $V_I = 15\text{ V}$ ,  $I_O = 40\text{ mA}$ ,  $C_I = 0.33\text{ }\mu\text{F}$ ,  $C_O = 0.1\text{ }\mu\text{F}$ ,  $-40^\circ\text{C} < T_J < +125^\circ\text{C}$  (for MC78LXXAB),  $0^\circ\text{C} < T_J < +125^\circ\text{C}$  (for MC78LXXAC), unless otherwise noted.)

| Characteristics  | Symbol                     | MC78L09AC, AB |           |            | Unit          |
|--|----------------------------|---------------|-----------|------------|---------------|
|  |                            | Min           | Typ       | Max        |               |
| Output Voltage ( $T_J = +25^\circ\text{C}$ )   | $V_O$                      | 8.6           | 9.0       | 9.4        | Vdc           |
| Line Regulation<br>( $T_J = +25^\circ\text{C}$ , $I_O = 40\text{ mA}$ )<br>$11.5\text{ Vdc} \leq V_I \leq 24\text{ Vdc}$<br>$12\text{ Vdc} \leq V_I \leq 24\text{ Vdc}$                  | $\text{Reg}_{\text{line}}$ | –<br>–        | 20<br>12  | 175<br>125 | mV            |
| Load Regulation<br>( $T_J = +25^\circ\text{C}$ , $1.0\text{ mA} \leq I_O \leq 100\text{ mA}$ )<br>( $T_J = +25^\circ\text{C}$ , $1.0\text{ mA} \leq I_O \leq 40\text{ mA}$ )             | $\text{Reg}_{\text{load}}$ | –<br>–        | 15<br>8.0 | 90<br>40   | mV            |
| Output Voltage<br>( $11.5\text{ Vdc} \leq V_I \leq 24\text{ Vdc}$ , $1.0\text{ mA} \leq I_O \leq 40\text{ mA}$ )<br>( $V_I = 15\text{ V}$ , $1.0\text{ mA} \leq I_O \leq 70\text{ mA}$ ) | $V_O$                      | 8.5<br>8.5    | –<br>–    | 9.5<br>9.5 | Vdc           |
| Input Bias Current<br>( $T_J = +25^\circ\text{C}$ )<br>( $T_J = +125^\circ\text{C}$ )  | $I_{\text{IB}}$            | –<br>–        | 3.0<br>–  | 6.0<br>5.5 | mA            |
| Input Bias Current Change<br>( $11\text{ Vdc} \leq V_I \leq 23\text{ Vdc}$ )<br>( $1.0\text{ mA} \leq I_O \leq 40\text{ mA}$ )   | $\Delta I_{\text{IB}}$     | –<br>–        | –<br>–    | 1.5<br>0.1 | mA            |
| Output Noise Voltage<br>( $T_A = +25^\circ\text{C}$ , $10\text{ Hz} \leq f \leq 100\text{ kHz}$ )  | $V_n$                      | –             | 60        | –          | $\mu\text{V}$ |
| Ripple Rejection ( $I_O = 40\text{ mA}$ ,<br>$f = 120\text{ Hz}$ , $13\text{ V} \leq V_I \leq 24\text{ V}$ , $T_J = +25^\circ\text{C}$ )   | RR                         | 37            | 57        | –          | dB            |
| Dropout Voltage<br>( $T_J = +25^\circ\text{C}$ )   | $V_I - V_O$                | –             | 1.7       | –          | Vdc           |

**ELECTRICAL CHARACTERISTICS** ( $V_I = 19\text{ V}$ ,  $I_O = 40\text{ mA}$ ,  $C_I = 0.33\text{ }\mu\text{F}$ ,  $C_O = 0.1\text{ }\mu\text{F}$ ,  $-40^\circ\text{C} < T_J < +125^\circ\text{C}$  (for MC78LXXAB),  $0^\circ\text{C} < T_J < +125^\circ\text{C}$  (for MC78LXXAC), unless otherwise noted.)

| Characteristics  | Symbol                     | MC78L12AC, AB |            |              | Unit          |
|--|----------------------------|---------------|------------|--------------|---------------|
|  |                            | Min           | Typ        | Max          |               |
| Output Voltage ( $T_J = +25^\circ\text{C}$ )   | $V_O$                      | 11.5          | 12         | 12.5         | Vdc           |
| Line Regulation<br>( $T_J = +25^\circ\text{C}$ , $I_O = 40\text{ mA}$ )<br>$14.5\text{ Vdc} \leq V_I \leq 27\text{ Vdc}$<br>$16\text{ Vdc} \leq V_I \leq 27\text{ Vdc}$                  | $\text{Reg}_{\text{line}}$ | –<br>–        | 120<br>100 | 250<br>200   | mV            |
| Load Regulation<br>( $T_J = +25^\circ\text{C}$ , $1.0\text{ mA} \leq I_O \leq 100\text{ mA}$ )<br>( $T_J = +25^\circ\text{C}$ , $1.0\text{ mA} \leq I_O \leq 40\text{ mA}$ )             | $\text{Reg}_{\text{load}}$ | –<br>–        | 20<br>10   | 100<br>50    | mV            |
| Output Voltage<br>( $14.5\text{ Vdc} \leq V_I \leq 27\text{ Vdc}$ , $1.0\text{ mA} \leq I_O \leq 40\text{ mA}$ )<br>( $V_I = 19\text{ V}$ , $1.0\text{ mA} \leq I_O \leq 70\text{ mA}$ ) | $V_O$                      | 11.4<br>11.4  | –<br>–     | 12.6<br>12.6 | Vdc           |
| Input Bias Current<br>( $T_J = +25^\circ\text{C}$ )<br>( $T_J = +125^\circ\text{C}$ )  | $I_{\text{IB}}$            | –<br>–        | 4.2<br>–   | 6.5<br>6.0   | mA            |
| Input Bias Current Change<br>( $16\text{ Vdc} \leq V_I \leq 27\text{ Vdc}$ )<br>( $1.0\text{ mA} \leq I_O \leq 40\text{ mA}$ )   | $\Delta I_{\text{IB}}$     | –<br>–        | –<br>–     | 1.5<br>0.1   | mA            |
| Output Noise Voltage<br>( $T_A = +25^\circ\text{C}$ , $10\text{ Hz} \leq f \leq 100\text{ kHz}$ )  | $V_n$                      | –             | 80         | –            | $\mu\text{V}$ |
| Ripple Rejection<br>( $I_O = 40\text{ mA}$ , $f = 120\text{ Hz}$ , $15\text{ V} \leq V_I \leq 25\text{ V}$ , $T_J = +25^\circ\text{C}$ )   | RR                         | 37            | 42         | –            | dB            |
| Dropout Voltage<br>( $T_J = +25^\circ\text{C}$ )   | $V_I - V_O$                | –             | 1.7        | –            | Vdc           |

## MC78L00A Series, NCV78L00A

**ELECTRICAL CHARACTERISTICS** ( $V_I = 23\text{ V}$ ,  $I_O = 40\text{ mA}$ ,  $C_I = 0.33\text{ }\mu\text{F}$ ,  $C_O = 0.1\text{ }\mu\text{F}$ ,  $-40^\circ\text{C} < T_J < +125^\circ\text{C}$  (for MC78LXXAB),  $0^\circ\text{C} < T_J < +125^\circ\text{C}$  (for MC78LXXAC), unless otherwise noted.)

| Characteristics  | Symbol                     | MC78L15AC, AB / NCV78L15A |            |                | Unit          |
|--|----------------------------|---------------------------|------------|----------------|---------------|
|  |                            | Min                       | Typ        | Max            |               |
| Output Voltage ( $T_J = +25^\circ\text{C}$ )   | $V_O$                      | 14.4                      | 15         | 15.6           | Vdc           |
| Line Regulation<br>( $T_J = +25^\circ\text{C}$ , $I_O = 40\text{ mA}$ )<br>$17.5\text{ Vdc} \leq V_I \leq 30\text{ Vdc}$<br>$20\text{ Vdc} \leq V_I \leq 30\text{ Vdc}$                  | $\text{Reg}_{\text{line}}$ | –<br>–                    | 130<br>110 | 300<br>250     | mV            |
| Load Regulation<br>( $T_J = +25^\circ\text{C}$ , $1.0\text{ mA} \leq I_O \leq 100\text{ mA}$ )<br>( $T_J = +25^\circ\text{C}$ , $1.0\text{ mA} \leq I_O \leq 40\text{ mA}$ )             | $\text{Reg}_{\text{load}}$ | –<br>–                    | 25<br>12   | 150<br>75      | mV            |
| Output Voltage<br>( $17.5\text{ Vdc} \leq V_I \leq 30\text{ Vdc}$ , $1.0\text{ mA} \leq I_O \leq 40\text{ mA}$ )<br>( $V_I = 23\text{ V}$ , $1.0\text{ mA} \leq I_O \leq 70\text{ mA}$ ) | $V_O$                      | 14.25<br>14.25            | –<br>–     | 15.75<br>15.75 | Vdc           |
| Input Bias Current<br>( $T_J = +25^\circ\text{C}$ )<br>( $T_J = +125^\circ\text{C}$ )  | $I_{\text{IB}}$            | –<br>–                    | 4.4<br>–   | 6.5<br>6.0     | mA            |
| Input Bias Current Change<br>( $20\text{ Vdc} \leq V_I \leq 30\text{ Vdc}$ )<br>( $1.0\text{ mA} \leq I_O \leq 40\text{ mA}$ )   | $\Delta I_{\text{IB}}$     | –<br>–                    | –<br>–     | 1.5<br>0.1     | mA            |
| Output Noise Voltage<br>( $T_A = +25^\circ\text{C}$ , $10\text{ Hz} \leq f \leq 100\text{ kHz}$ )  | $V_n$                      | –                         | 90         | –              | $\mu\text{V}$ |
| Ripple Rejection<br>( $I_O = 40\text{ mA}$ , $f = 120\text{ Hz}$ , $18.5\text{ V} \leq V_I \leq 28.5\text{ V}$ , $T_J = +25^\circ\text{C}$ )   | RR                         | 34                        | 39         | –              | dB            |
| Dropout Voltage<br>( $T_J = +25^\circ\text{C}$ )   | $V_I - V_O$                | –                         | 1.7        | –              | Vdc           |

**ELECTRICAL CHARACTERISTICS** ( $V_I = 27\text{ V}$ ,  $I_O = 40\text{ mA}$ ,  $C_I = 0.33\text{ }\mu\text{F}$ ,  $C_O = 0.1\text{ }\mu\text{F}$ ,  $0^\circ\text{C} < T_J < +125^\circ\text{C}$ , unless otherwise noted.)

| Characteristics  | Symbol                     | MC78L18AC    |          |              | Unit          |
|--|----------------------------|--------------|----------|--------------|---------------|
|  |                            | Min          | Typ      | Max          |               |
| Output Voltage ( $T_J = +25^\circ\text{C}$ )   | $V_O$                      | 17.3         | 18       | 18.7         | Vdc           |
| Line Regulation<br>( $T_J = +25^\circ\text{C}$ , $I_O = 40\text{ mA}$ )<br>$21.4\text{ Vdc} \leq V_I \leq 33\text{ Vdc}$<br>$20.7\text{ Vdc} \leq V_I \leq 33\text{ Vdc}$<br>$22\text{ Vdc} \leq V_I \leq 33\text{ Vdc}$<br>$21\text{ Vdc} \leq V_I \leq 33\text{ Vdc}$  | $\text{Reg}_{\text{line}}$ | –<br>–       | 45<br>35 | 325<br>275   | mV            |
| Load Regulation<br>( $T_J = +25^\circ\text{C}$ , $1.0\text{ mA} \leq I_O \leq 100\text{ mA}$ )<br>( $T_J = +25^\circ\text{C}$ , $1.0\text{ mA} \leq I_O \leq 40\text{ mA}$ )   | $\text{Reg}_{\text{load}}$ | –<br>–       | 30<br>15 | 170<br>85    | mV            |
| Output Voltage<br>( $21.4\text{ Vdc} \leq V_I \leq 33\text{ Vdc}$ , $1.0\text{ mA} \leq I_O \leq 40\text{ mA}$ )<br>( $20.7\text{ Vdc} \leq V_I \leq 33\text{ Vdc}$ , $1.0\text{ mA} \leq I_O \leq 40\text{ mA}$ )<br>( $V_I = 27\text{ V}$ , $1.0\text{ mA} \leq I_O \leq 70\text{ mA}$ )<br>( $V_I = 27\text{ V}$ , $1.0\text{ mA} \leq I_O \leq 70\text{ mA}$ ) | $V_O$                      | 17.1<br>17.1 | –<br>–   | 18.9<br>18.9 | Vdc           |
| Input Bias Current<br>( $T_J = +25^\circ\text{C}$ )<br>( $T_J = +125^\circ\text{C}$ )  | $I_{\text{IB}}$            | –<br>–       | 3.1<br>– | 6.5<br>6.0   | mA            |
| Input Bias Current Change<br>( $22\text{ Vdc} \leq V_I \leq 33\text{ Vdc}$ )<br>( $21\text{ Vdc} \leq V_I \leq 33\text{ Vdc}$ )<br>( $1.0\text{ mA} \leq I_O \leq 40\text{ mA}$ )  | $\Delta I_{\text{IB}}$     | –<br>–       | –<br>–   | 1.5<br>0.1   | mA            |
| Output Noise Voltage<br>( $T_A = +25^\circ\text{C}$ , $10\text{ Hz} \leq f \leq 100\text{ kHz}$ )  | $V_n$                      | –            | 150      | –            | $\mu\text{V}$ |
| Ripple Rejection<br>( $I_O = 40\text{ mA}$ , $f = 120\text{ Hz}$ , $23\text{ V} \leq V_I \leq 33\text{ V}$ , $T_J = +25^\circ\text{C}$ )   | RR                         | 33           | 48       | –            | dB            |
| Dropout Voltage<br>( $T_J = +25^\circ\text{C}$ )   | $V_I - V_O$                | –            | 1.7      | –            | Vdc           |

## MC78L00A Series, NCV78L00A

**ELECTRICAL CHARACTERISTICS** ( $V_I = 33\text{ V}$ ,  $I_O = 40\text{ mA}$ ,  $C_I = 0.33\text{ }\mu\text{F}$ ,  $C_O = 0.1\text{ }\mu\text{F}$ ,  $0^\circ\text{C} < T_J < +125^\circ\text{C}$ , unless otherwise noted.)

| Characteristics  | Symbol                     | MC78L24AC |     |      | Unit          |
|--|----------------------------|-----------|-----|------|---------------|
|  |                            | Min       | Typ | Max  |               |
| Output Voltage ( $T_J = +25^\circ\text{C}$ )   | $V_O$                      | 23        | 24  | 25   | Vdc           |
| Line Regulation<br>( $T_J = +25^\circ\text{C}$ , $I_O = 40\text{ mA}$ )<br>$27.5\text{ Vdc} \leq V_I \leq 38\text{ Vdc}$<br>$28\text{ Vdc} \leq V_I \leq 80\text{ Vdc}$<br>$27\text{ Vdc} \leq V_I \leq 38\text{ Vdc}$   | $\text{Reg}_{\text{line}}$ | –         | –   | –    | mV            |
| Load Regulation<br>( $T_J = +25^\circ\text{C}$ , $1.0\text{ mA} \leq I_O \leq 100\text{ mA}$ )<br>( $T_J = +25^\circ\text{C}$ , $1.0\text{ mA} \leq I_O \leq 40\text{ mA}$ )   | $\text{Reg}_{\text{load}}$ | –         | 40  | 200  | mV            |
| Output Voltage<br>( $28\text{ Vdc} \leq V_I \leq 38\text{ Vdc}$ , $1.0\text{ mA} \leq I_O \leq 40\text{ mA}$ )<br>( $27\text{ Vdc} \leq V_I \leq 38\text{ Vdc}$ , $1.0\text{ mA} \leq I_O \leq 40\text{ mA}$ )<br>( $28\text{ Vdc} \leq V_I \leq 33\text{ Vdc}$ , $1.0\text{ mA} \leq I_O \leq 70\text{ mA}$ )<br>( $27\text{ Vdc} \leq V_I \leq 33\text{ Vdc}$ , $1.0\text{ mA} \leq I_O \leq 70\text{ mA}$ ) | $V_O$                      | 22.8      | –   | 25.2 | Vdc           |
| Input Bias Current<br>( $T_J = +25^\circ\text{C}$ )<br>( $T_J = +125^\circ\text{C}$ )  | $I_{\text{IB}}$            | –         | 3.1 | 6.5  | mA            |
| Input Bias Current Change<br>( $28\text{ Vdc} \leq V_I \leq 38\text{ Vdc}$ )<br>( $1.0\text{ mA} \leq I_O \leq 40\text{ mA}$ )   | $\Delta I_{\text{IB}}$     | –         | –   | 1.5  | mA            |
| Output Noise Voltage<br>( $T_A = +25^\circ\text{C}$ , $10\text{ Hz} \leq f \leq 100\text{ kHz}$ )  | $V_n$                      | –         | 200 | –    | $\mu\text{V}$ |
| Ripple Rejection<br>( $I_O = 40\text{ mA}$ , $f = 120\text{ Hz}$ , $29\text{ V} \leq V_I \leq 35\text{ V}$ , $T_J = +25^\circ\text{C}$ )   | RR                         | 31        | 45  | –    | dB            |
| Dropout Voltage<br>( $T_J = +25^\circ\text{C}$ )   | $V_I - V_O$                | –         | 1.7 | –    | Vdc           |

Product parametric performance is indicated in the Electrical Characteristics for the listed test conditions, unless otherwise noted. Product performance may not be indicated by the Electrical Characteristics if operated under different conditions.

# MC78L00A Series, NCV78L00A

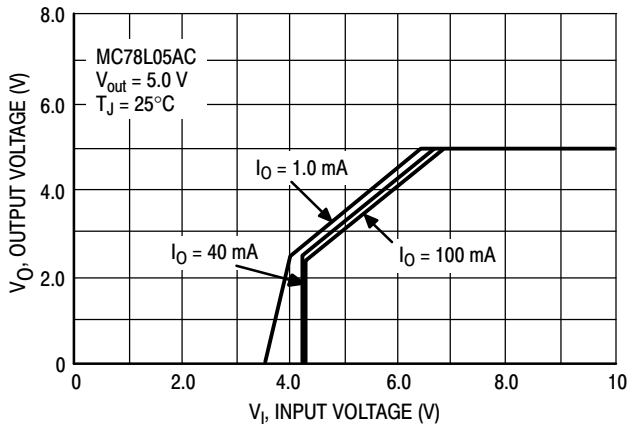

Figure 3. Dropout Characteristics

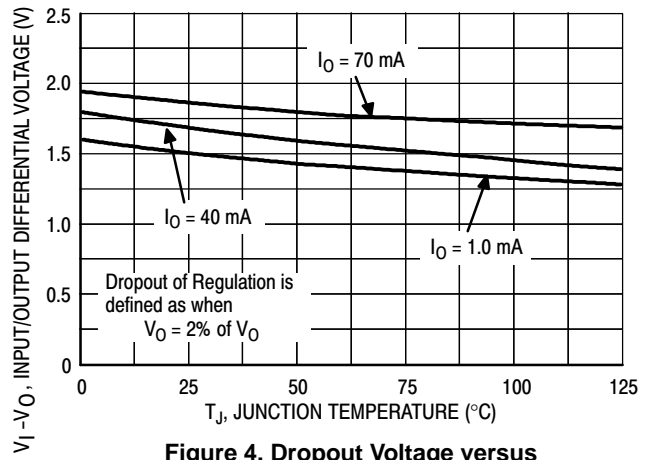

Figure 4. Dropout Voltage versus Junction Temperature

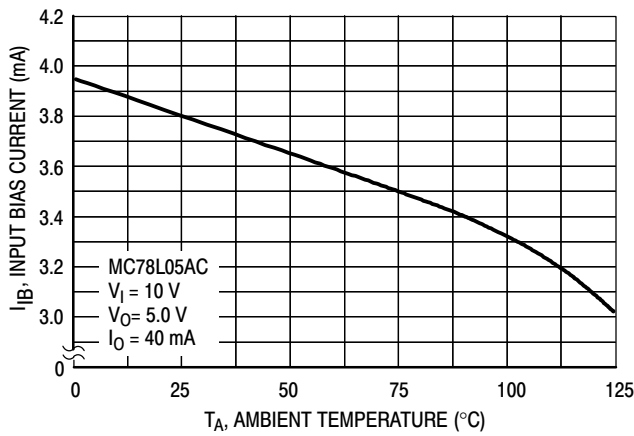

Figure 5. Input Bias Current versus Ambient Temperature

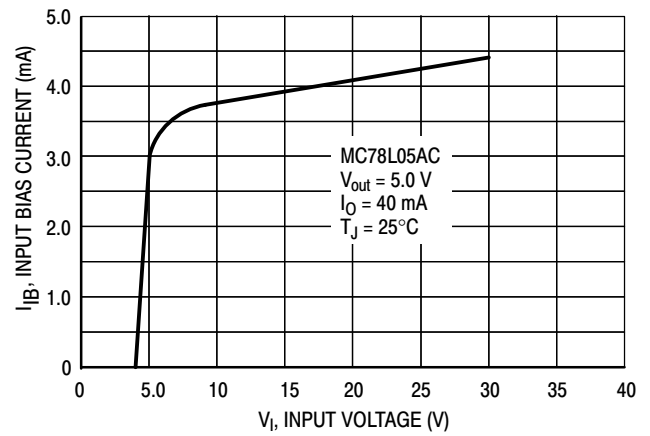

Figure 6. Input Bias Current versus Input Voltage

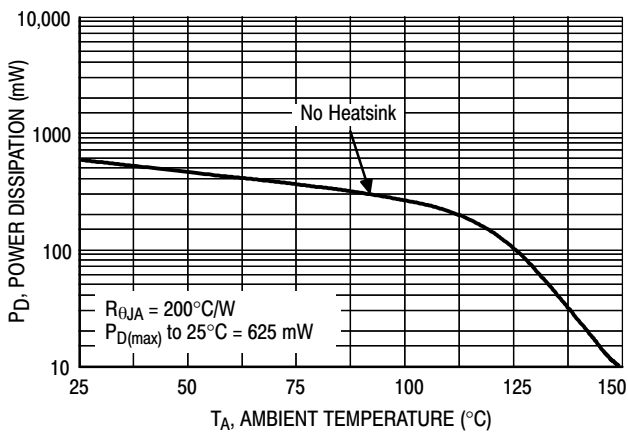

Figure 7. Maximum Average Power Dissipation versus Ambient Temperature – TO-92 Type Package

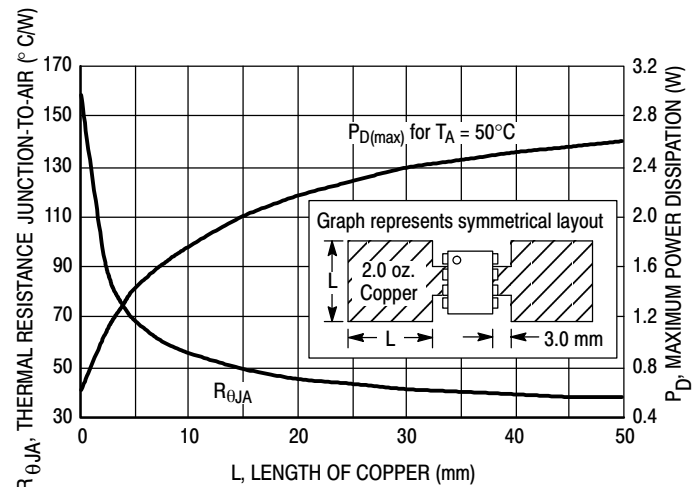

Figure 8. SOIC-8 Thermal Resistance and Maximum Power Dissipation versus P.C.B. Copper Length

# MC78L00A Series, NCV78L00A

## APPLICATIONS INFORMATION

### Design Considerations

The MC78L00A Series of fixed voltage regulators are designed with Thermal Overload Protection that shuts down the circuit when subjected to an excessive power overload condition. Internal Short Circuit Protection limits the maximum current the circuit will pass.

In many low current applications, compensation capacitors are not required. However, it is recommended that the regulator input be bypassed with a capacitor if the regulator is connected to the power supply filter with long wire lengths, or if the output load capacitance is large. The

input bypass capacitor should be selected to provide good high-frequency characteristics to insure stable operation under all load conditions. A 0.33 μF or larger tantalum, mylar, or other capacitor having low internal impedance at high frequencies should be chosen. The bypass capacitor should be mounted with the shortest possible leads directly across the regulators input terminals. Good construction techniques should be used to minimize ground loops and lead resistance drops since the regulator has no external sense lead. Bypassing the output is also recommended.

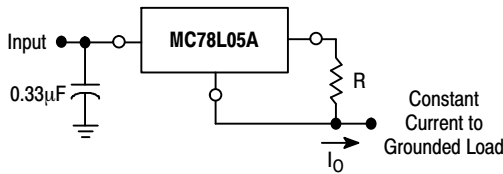

The MC78L00 regulators can also be used as a current source when connected as above. In order to minimize dissipation the MC78L05C is chosen in this application. Resistor R determines the current as follows:

$$I_O = \frac{5.0 \text{ V}}{R} + I_B$$

$$I_B = 3.8 \text{ mA over line and load changes}$$

For example, a 100 mA current source would require R to be a 50 Ω, 1/2 W resistor and the output voltage compliance would be the input voltage less 7 V.

Figure 9. Current Regulator

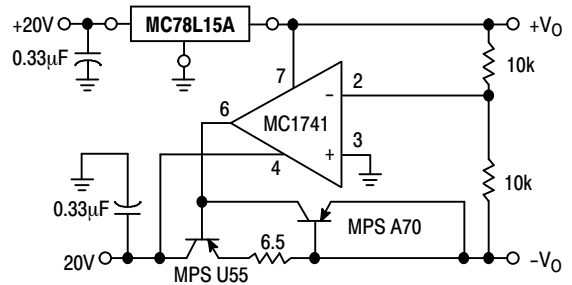

Figure 10. ±15 V Tracking Voltage Regulator

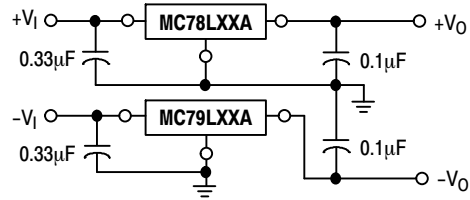

Figure 11. Positive and Negative Regulator



## MC78L00A Series, NCV78L00A

### ORDERING INFORMATION

| Device          | Output Voltage | Operating Temperature Range     | Package             | Shipping <sup>†</sup> |
|-----------------|----------------|---------------------------------|---------------------|-----------------------|
| MC78L05ABDG     | 5.0 V          | T <sub>J</sub> = -40° to +125°C | SOIC-8<br>(Pb-Free) | 98 Units / Rail       |
| NCV78L05ABDG*   | 5.0 V          | T <sub>J</sub> = -40° to +125°C | SOIC-8<br>(Pb-Free) | 98 Units / Rail       |
| MC78L05ABDR2G   | 5.0 V          | T <sub>J</sub> = -40° to +125°C | SOIC-8<br>(Pb-Free) | 2500 / Tape & Reel    |
| NCV78L05ABDR2G* | 5.0 V          | T <sub>J</sub> = -40° to +125°C | SOIC-8<br>(Pb-Free) | 2500 / Tape & Reel    |
| MC78L05ABPG     | 5.0 V          | T <sub>J</sub> = -40° to +125°C | TO-92<br>(Pb-Free)  | 2000 Units / Bag      |
| NCV78L05ABPG*   | 5.0 V          | T <sub>J</sub> = -40° to +125°C | TO-92<br>(Pb-Free)  | 2000 Units / Bag      |
| MC78L05ABPRAG   | 5.0 V          | T <sub>J</sub> = -40° to +125°C | TO-92<br>(Pb-Free)  | 2000 / Tape & Reel    |
| NCV78L05ABPRAG* | 5.0 V          | T <sub>J</sub> = -40° to +125°C | TO-92<br>(Pb-Free)  | 2000 / Tape & Reel    |
| MC78L05ABPREG   | 5.0 V          | T <sub>J</sub> = -40° to +125°C | TO-92<br>(Pb-Free)  | 2000 / Tape & Reel    |
| NCV78L05ABPREG* | 5.0 V          | T <sub>J</sub> = -40° to +125°C | TO-92<br>(Pb-Free)  | 2000 / Tape & Reel    |
| MC78L05ABPRMG   | 5.0 V          | T <sub>J</sub> = -40° to +125°C | TO-92<br>(Pb-Free)  | 2000 / Ammo Pack      |
| NCV78L05ABPRMG* | 5.0 V          | T <sub>J</sub> = -40° to +125°C | TO-92<br>(Pb-Free)  | 2000 / Ammo Pack      |
| NCV78L05ABPRPG* | 5.0 V          | T <sub>J</sub> = -40° to +125°C | TO-92<br>(Pb-Free)  | 2000 / Ammo Pack      |
| MC78L05ACDG     | 5.0 V          | T <sub>J</sub> = 0° to +125°C   | SOIC-8<br>(Pb-Free) | 98 Units / Rail       |
| MC78L05ACDR2G   | 5.0 V          | T <sub>J</sub> = 0° to +125°C   | SOIC-8<br>(Pb-Free) | 2500 / Tape & Reel    |
| MC78L05ACPG     | 5.0 V          | T <sub>J</sub> = 0° to +125°C   | TO-92<br>(Pb-Free)  | 2000 Units / Bag      |
| MC78L05ACPRAG   | 5.0 V          | T <sub>J</sub> = 0° to +125°C   | TO-92<br>(Pb-Free)  | 2000 / Tape & Reel    |
| MC78L05ACPREG   | 5.0 V          | T <sub>J</sub> = 0° to +125°C   | TO-92<br>(Pb-Free)  | 2000 / Tape & Reel    |
| MC78L05ACPRMG   | 5.0 V          | T <sub>J</sub> = 0° to +125°C   | TO-92<br>(Pb-Free)  | 2000 / Ammo Pack      |
| MC78L05ACPRPG   | 5.0 V          | T <sub>J</sub> = 0° to +125°C   | TO-92<br>(Pb-Free)  | 2000 / Ammo Pack      |
| MC78L05ACHT1G   | 5.0 V          | T <sub>J</sub> = 0° to +125°C   | SOT-89<br>(Pb-Free) | 2500 / Tape & Reel    |
| MC78L08ABDG     | 8.0 V          | T <sub>J</sub> = -40° to +125°C | SOIC-8<br>(Pb-Free) | 98 Units / Rail       |

\*NCV78L05A, NCV78L12A, NCV78L15A: T<sub>low</sub> = -40°C, T<sub>high</sub> = +125°C. Guaranteed by design. NCV Prefix for Automotive and Other Applications Requiring Unique Site and Control Change Requirements; AEC-Q100 Qualified and PPAP Capable.

†For information on tape and reel specifications, including part orientation and tape sizes, please refer to our Tape and Reel Packaging Specifications Brochure, BRD8011/D.

## MC78L00A Series, NCV78L00A

### ORDERING INFORMATION (continued)

| Device          | Output Voltage | Operating Temperature Range     | Package             | Shipping <sup>†</sup> |
|-----------------|----------------|---------------------------------|---------------------|-----------------------|
| MC78L08ABDR2G   | 8.0 V          | T <sub>J</sub> = -40° to +125°C | SOIC-8<br>(Pb-Free) | 2500 / Tape & Reel    |
| NCV78L08ABDR2G* | 8.0 V          | T <sub>J</sub> = -40° to +125°C | SOIC-8<br>(Pb-Free) | 2500 / Tape & Reel    |
| MC78L08ABPG     | 8.0 V          | T <sub>J</sub> = -40° to +125°C | TO-92<br>(Pb-Free)  | 2000 Units / Bag      |
| MC78L08ABPRAG   | 8.0 V          | T <sub>J</sub> = -40° to +125°C | TO-92<br>(Pb-Free)  | 2000 / Tape & Reel    |
| MC78L08ABPRPG   | 8.0 V          | T <sub>J</sub> = -40° to +125°C | TO-92<br>(Pb-Free)  | 2000 / Ammo Pack      |
| MC78L08ACDG     | 8.0 V          | T <sub>J</sub> = 0° to +125°C   | SOIC-8<br>(Pb-Free) | 98 Units / Rail       |
| MC78L08ACDR2G   | 8.0 V          | T <sub>J</sub> = 0° to +125°C   | SOIC-8<br>(Pb-Free) | 2500 / Tape & Reel    |
| MC78L08ACPG     | 8.0 V          | T <sub>J</sub> = 0° to +125°C   | TO-92<br>(Pb-Free)  | 2000 Units / Bag      |
| MC78L08ACPRAG   | 8.0 V          | T <sub>J</sub> = 0° to +125°C   | TO-92<br>(Pb-Free)  | 2000 / Tape & Reel    |
| MC78L08ACPREG   | 8.0 V          | T <sub>J</sub> = 0° to +125°C   | TO-92<br>(Pb-Free)  | 2000 / Tape & Reel    |
| MC78L08ACPRPG   | 8.0 V          | T <sub>J</sub> = 0° to +125°C   | TO-92<br>(Pb-Free)  | 2000 / Ammo Pack      |
| MC78L09ABDG     | 9.0 V          | T <sub>J</sub> = -40° to +125°C | SOIC-8<br>(Pb-Free) | 98 Units / Rail       |
| MC78L09ABDR2G   | 9.0 V          | T <sub>J</sub> = -40° to +125°C | SOIC-8<br>(Pb-Free) | 2500 / Tape & Reel    |
| MC78L09ABPRAG   | 9.0 V          | T <sub>J</sub> = -40° to +125°C | TO-92<br>(Pb-Free)  | 2000 / Tape & Reel    |
| MC78L09ABPRPG   | 9.0 V          | T <sub>J</sub> = -40° to +125°C | TO-92<br>(Pb-Free)  | 2000 / Ammo Pack      |
| MC78L09ACDG     | 9.0 V          | T <sub>J</sub> = 0° to +125°C   | SOIC-8<br>(Pb-Free) | 98 Units / Rail       |
| MC78L09ACDR2G   | 9.0 V          | T <sub>J</sub> = 0° to +125°C   | SOIC-8<br>(Pb-Free) | 2500 / Tape & Reel    |
| MC78L09ACPG     | 9.0 V          | T <sub>J</sub> = 0° to +125°C   | TO-92<br>(Pb-Free)  | 2000 Units / Bag      |
| MC78L12ABDG     | 12 V           | T <sub>J</sub> = -40° to +125°C | SOIC-8<br>(Pb-Free) | 98 Units / Rail       |
| MC78L12ABDR2G   | 12 V           | T <sub>J</sub> = -40° to +125°C | SOIC-8<br>(Pb-Free) | 2500 / Tape & Reel    |
| NCV78L12ABDG*   | 12 V           | T <sub>J</sub> = -40° to +125°C | SOIC-8<br>(Pb-Free) | 98 Units / Rail       |
| NCV78L12ABDR2G* | 12 V           | T <sub>J</sub> = -40° to +125°C | SOIC-8<br>(Pb-Free) | 2500 / Tape & Reel    |
| MC78L12ABPG     | 12 V           | T <sub>J</sub> = -40° to +125°C | TO-92<br>(Pb-Free)  | 2000 Units / Bag      |

\*NCV78L05A, NCV78L12A, NCV78L15A: T<sub>low</sub> = -40°C, T<sub>high</sub> = +125°C. Guaranteed by design. NCV Prefix for Automotive and Other Applications Requiring Unique Site and Control Change Requirements; AEC-Q100 Qualified and PPAP Capable.

†For information on tape and reel specifications, including part orientation and tape sizes, please refer to our Tape and Reel Packaging Specifications Brochure, BRD8011/D.

## MC78L00A Series, NCV78L00A

### ORDERING INFORMATION (continued)

| Device          | Output Voltage | Operating Temperature Range     | Package             | Shipping <sup>†</sup> |
|-----------------|----------------|---------------------------------|---------------------|-----------------------|
| MC78L12ABPRPG   | 12 V           | T <sub>J</sub> = -40° to +125°C | TO-92<br>(Pb-Free)  | 2000 / Ammo Pack      |
| NCV78L12ABPG*   | 12 V           | T <sub>J</sub> = -40° to +125°C | TO-92<br>(Pb-Free)  | 2000 Units / Bag      |
| MC78L12ACDG     | 12 V           | T <sub>J</sub> = 0° to +125°C   | SOIC-8<br>(Pb-Free) | 98 Units / Rail       |
| MC78L12ACDR2G   | 12 V           | T <sub>J</sub> = 0° to +125°C   | SOIC-8<br>(Pb-Free) | 2500 / Tape & Reel    |
| MC78L12ACPG     | 12 V           | T <sub>J</sub> = 0° to +125°C   | TO-92<br>(Pb-Free)  | 2000 Units / Bag      |
| MC78L12ACPRAG   | 12 V           | T <sub>J</sub> = 0° to +125°C   | TO-92<br>(Pb-Free)  | 2000 / Tape & Reel    |
| MC78L12ACPREG   | 12 V           | T <sub>J</sub> = 0° to +125°C   | TO-92<br>(Pb-Free)  | 2000 / Tape & Reel    |
| MC78L12ACPRMG   | 12 V           | T <sub>J</sub> = 0° to +125°C   | TO-92<br>(Pb-Free)  | 2000 / Ammo Pack      |
| MC78L12ACPRPG   | 12 V           | T <sub>J</sub> = 0° to +125°C   | TO-92<br>(Pb-Free)  | 2000 / Ammo Pack      |
| MC78L15ABDG     | 15 V           | T <sub>J</sub> = -40° to +125°C | SOIC-8<br>(Pb-Free) | 98 Units / Rail       |
| MC78L15ABDR2G   | 15 V           | T <sub>J</sub> = -40° to +125°C | SOIC-8<br>(Pb-Free) | 2500 / Tape & Reel    |
| NCV78L15ABDR2G* | 15 V           | T <sub>J</sub> = -40° to +125°C | SOIC-8<br>(Pb-Free) | 2500 / Tape & Reel    |
| MC78L15ABPG     | 15 V           | T <sub>J</sub> = -40° to +125°C | TO-92<br>(Pb-Free)  | 2000 Units / Bag      |
| MC78L15ABPRAG   | 15 V           | T <sub>J</sub> = -40° to +125°C | TO-92<br>(Pb-Free)  | 2000 / Tape & Reel    |
| MC78L15ABPRPG   | 15 V           | T <sub>J</sub> = -40° to +125°C | TO-92<br>(Pb-Free)  | 2000 / Ammo Pack      |
| MC78L15ACDG     | 15 V           | T <sub>J</sub> = 0° to +125°C   | SOIC-8<br>(Pb-Free) | 98 Units / Rail       |
| MC78L15ACDR2G   | 15 V           | T <sub>J</sub> = 0° to +125°C   | SOIC-8<br>(Pb-Free) | 2500 / Tape & Reel    |
| MC78L15ACPG     | 15 V           | T <sub>J</sub> = 0° to +125°C   | TO-92<br>(Pb-Free)  | 2000 Units / Bag      |
| MC78L15ACPRAG   | 15 V           | T <sub>J</sub> = 0° to +125°C   | TO-92<br>(Pb-Free)  | 2000 / Tape & Reel    |
| MC78L15ACPRPG   | 15 V           | T <sub>J</sub> = 0° to +125°C   | TO-92<br>(Pb-Free)  | 2000 / Ammo Pack      |
| MC78L18ABPG     | 18 V           | T <sub>J</sub> = -40° to +125°C | TO-92<br>(Pb-Free)  | 2000 Units / Bag      |
| MC78L18ACPG     | 18 V           | T <sub>J</sub> = 0° to +125°C   | TO-92<br>(Pb-Free)  | 2000 Units / Bag      |
| MC78L18ACPRAG   | 18 V           | T <sub>J</sub> = 0° to +125°C   | TO-92<br>(Pb-Free)  | 2000 / Tape & Reel    |

\*NCV78L05A, NCV78L12A, NCV78L15A: T<sub>low</sub> = -40°C, T<sub>high</sub> = +125°C. Guaranteed by design. NCV Prefix for Automotive and Other Applications Requiring Unique Site and Control Change Requirements; AEC-Q100 Qualified and PPAP Capable.

†For information on tape and reel specifications, including part orientation and tape sizes, please refer to our Tape and Reel Packaging Specifications Brochure, BRD8011/D.

# MC78L00A Series, NCV78L00A

## ORDERING INFORMATION (continued)

| Device          | Output Voltage | Operating Temperature Range     | Package            | Shipping <sup>†</sup> |
|-----------------|----------------|---------------------------------|--------------------|-----------------------|
| MC78L18ACPRMG   | 18 V           | T <sub>J</sub> = 0° to +125°C   | TO-92<br>(Pb-Free) | 2000 / Ammo Pack      |
| MC78L18ACPRPG   | 18 V           | T <sub>J</sub> = 0° to +125°C   | TO-92<br>(Pb-Free) | 2000 / Ammo Pack      |
| MC78L24ABPG     | 24 V           | T <sub>J</sub> = -40° to +125°C | TO-92<br>(Pb-Free) | 2000 Units / Bag      |
| NCV78L24ABPRPG* | 24 V           | T <sub>J</sub> = -40° to +125°C | TO-92<br>(Pb-Free) | 2000 Units / Bag      |
| MC78L24ACPG     | 24 V           | T <sub>J</sub> = 0° to +125°C   | TO-92<br>(Pb-Free) | 2000 Units / Bag      |
| MC78L24ACPRAG   | 24 V           | T <sub>J</sub> = 0° to +125°C   | TO-92<br>(Pb-Free) | 2000 / Tape & Reel    |
| MC78L24ACPRPG   | 24 V           | T <sub>J</sub> = 0° to +125°C   | TO-92<br>(Pb-Free) | 2000 / Ammo Pack      |

\*NCV78L05A, NCV78L12A, NCV78L15A: T<sub>low</sub> = -40°C, T<sub>high</sub> = +125°C. Guaranteed by design. NCV Prefix for Automotive and Other Applications Requiring Unique Site and Control Change Requirements; AEC-Q100 Qualified and PPAP Capable.

†For information on tape and reel specifications, including part orientation and tape sizes, please refer to our Tape and Reel Packaging Specifications Brochure, BRD8011/D.

## MARKING DIAGRAMS

### SOIC-8 D SUFFIX CASE 751

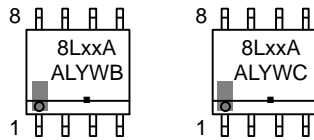

xx = 05, 08, 09, 12, or 15  
 A = Assembly Location  
 L = Wafer Lot  
 Y = Year  
 W = Work Week  
 B, C = Temperature Range  
 ■ = Pb-Free Package

### SOT-89 CASE 528AG

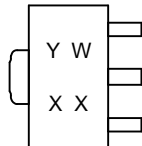

Y = Year  
 W = Work Week  
 XX = Specific Device Code

### TO-92 P SUFFIX CASE 029

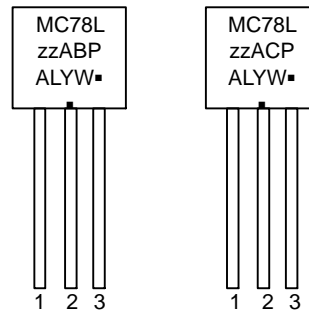

zz = 05, 08, 09, 12, 15, 18 or 24  
 A = Assembly Location  
 L = Wafer Lot  
 Y = Year  
 W = Work Week  
 ■ = Pb-Free Package  
 (Note: Microdot may be in either location)

# MECHANICAL CASE OUTLINE

## PACKAGE DIMENSIONS

ON Semiconductor®



SCALE 1:1

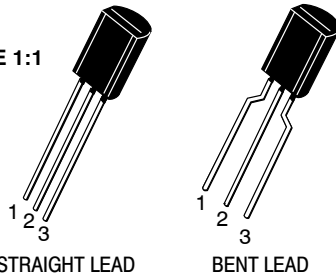

TO-92 (TO-226) 1 WATT  
CASE 29-10  
ISSUE A

DATE 08 MAY 2012

STRAIGHT LEAD

BENT LEAD

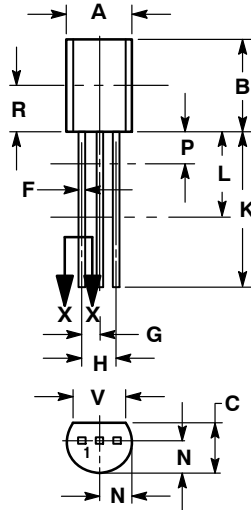

STRAIGHT LEAD

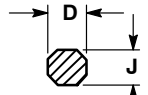

SECTION X-X

NOTES:

1. DIMENSIONING AND TOLERANCING PER ANSI Y14.5M, 1994.
2. CONTROLLING DIMENSION: INCHES.
3. CONTOUR OF PACKAGE BEYOND DIMENSION R IS UNCONTROLLED.
4. DIMENSION F APPLIES BETWEEN DIMENSIONS P AND L. DIMENSIONS D AND J APPLY BETWEEN DIMENSIONS L AND K MINIMUM. THE LEAD DIMENSIONS ARE UNCONTROLLED IN DIMENSION P AND BEYOND DIMENSION K MINIMUM.

| DIM | INCHES |       | MILLIMETERS |      |
|-----|--------|-------|-------------|------|
|     | MIN    | MAX   | MIN         | MAX  |
| A   | 0.175  | 0.205 | 4.44        | 5.21 |
| B   | 0.290  | 0.310 | 7.37        | 7.87 |
| C   | 0.125  | 0.165 | 3.18        | 4.19 |
| D   | 0.018  | 0.021 | 0.46        | 0.53 |
| F   | 0.016  | 0.019 | 0.41        | 0.48 |
| G   | 0.045  | 0.055 | 1.15        | 1.39 |
| H   | 0.095  | 0.105 | 2.42        | 2.66 |
| J   | 0.018  | 0.024 | 0.46        | 0.61 |
| K   | 0.500  | ---   | 12.70       | ---  |
| L   | 0.250  | ---   | 6.35        | ---  |
| N   | 0.080  | 0.105 | 2.04        | 2.66 |
| P   | ---    | 0.100 | ---         | 2.54 |
| R   | 0.135  | ---   | 3.43        | ---  |
| V   | 0.135  | ---   | 3.43        | ---  |

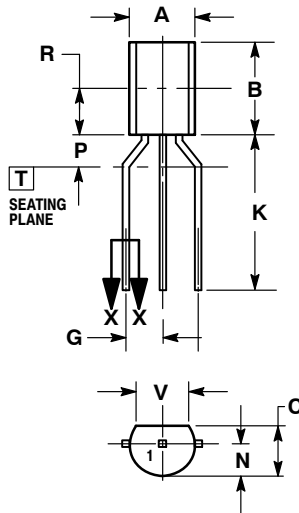

BENT LEAD

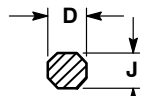

SECTION X-X

NOTES:

1. DIMENSIONING AND TOLERANCING PER ASME Y14.5M, 1994.
2. CONTROLLING DIMENSION: INCHES.
3. CONTOUR OF PACKAGE BEYOND DIMENSION R IS UNCONTROLLED.
4. DIMENSION F APPLIES BETWEEN DIMENSIONS P AND L. DIMENSIONS D AND J APPLY BETWEEN DIMENSIONS L AND K MINIMUM. THE LEAD DIMENSIONS ARE UNCONTROLLED IN DIMENSION P AND BEYOND DIMENSION K MINIMUM.

| DIM | INCHES |       | MILLIMETERS |      |
|-----|--------|-------|-------------|------|
|     | MIN    | MAX   | MIN         | MAX  |
| A   | 0.175  | 0.205 | 4.44        | 5.21 |
| B   | 0.290  | 0.310 | 7.37        | 7.87 |
| C   | 0.125  | 0.165 | 3.18        | 4.19 |
| D   | 0.018  | 0.021 | 0.46        | 0.53 |
| G   | 0.094  | 0.102 | 2.40        | 2.80 |
| J   | 0.018  | 0.024 | 0.46        | 0.61 |
| K   | 0.500  | ---   | 12.70       | ---  |
| N   | 0.080  | 0.105 | 2.04        | 2.66 |
| P   | ---    | 0.100 | ---         | 2.54 |
| R   | 0.135  | ---   | 3.43        | ---  |
| V   | 0.135  | ---   | 3.43        | ---  |

STYLES ON PAGE 2

|                         |                              |  |
|-------------------------|------------------------------|--|
| <b>DOCUMENT NUMBER:</b> | <b>98AON52857E</b>           | Electronic versions are uncontrolled except when accessed directly from the Document Repository. Printed versions are uncontrolled except when stamped "CONTROLLED COPY" in red. |
| <b>DESCRIPTION:</b>     | <b>TO-92 (TO-226) 1 WATT</b> | <b>PAGE 1 OF 2</b>   |

ON Semiconductor and are trademarks of Semiconductor Components Industries, LLC dba ON Semiconductor or its subsidiaries in the United States and/or other countries. ON Semiconductor reserves the right to make changes without further notice to any products herein. ON Semiconductor makes no warranty, representation or guarantee regarding the suitability of its products for any particular purpose, nor does ON Semiconductor assume any liability arising out of the application or use of any product or circuit, and specifically disclaims any and all liability, including without limitation special, consequential or incidental damages. ON Semiconductor does not convey any license under its patent rights nor the rights of others.

**TO-92 (TO-226) 1 WATT  
CASE 29-10  
ISSUE A**

DATE 08 MAY 2012

- |   |  |  |   |   |
|---|--|--|---|---|
| <p>STYLE 1:<br/>PIN 1. EMITTER<br/>2. BASE<br/>3. COLLECTOR</p>             | <p>STYLE 2:<br/>PIN 1. BASE<br/>2. EMITTER<br/>3. COLLECTOR</p>                | <p>STYLE 3:<br/>PIN 1. ANODE<br/>2. ANODE<br/>3. CATHODE</p>               | <p>STYLE 4:<br/>PIN 1. CATHODE<br/>2. CATHODE<br/>3. ANODE</p>            | <p>STYLE 5:<br/>PIN 1. DRAIN<br/>2. SOURCE<br/>3. GATE</p>            |
| <p>STYLE 6:<br/>PIN 1. GATE<br/>2. SOURCE &amp; SUBSTRATE<br/>3. DRAIN</p>  | <p>STYLE 7:<br/>PIN 1. SOURCE<br/>2. DRAIN<br/>3. GATE</p>                     | <p>STYLE 8:<br/>PIN 1. DRAIN<br/>2. GATE<br/>3. SOURCE &amp; SUBSTRATE</p> | <p>STYLE 9:<br/>PIN 1. BASE 1<br/>2. EMITTER<br/>3. BASE 2</p>            | <p>STYLE 10:<br/>PIN 1. CATHODE<br/>2. GATE<br/>3. ANODE</p>          |
| <p>STYLE 11:<br/>PIN 1. ANODE<br/>2. CATHODE &amp; ANODE<br/>3. CATHODE</p> | <p>STYLE 12:<br/>PIN 1. MAIN TERMINAL 1<br/>2. GATE<br/>3. MAIN TERMINAL 2</p> | <p>STYLE 13:<br/>PIN 1. ANODE 1<br/>2. GATE<br/>3. CATHODE 2</p>           | <p>STYLE 14:<br/>PIN 1. EMITTER<br/>2. COLLECTOR<br/>3. BASE</p>          | <p>STYLE 15:<br/>PIN 1. ANODE 1<br/>2. CATHODE<br/>3. ANODE 2</p>     |
| <p>STYLE 16:<br/>PIN 1. ANODE<br/>2. GATE<br/>3. CATHODE</p>                | <p>STYLE 17:<br/>PIN 1. COLLECTOR<br/>2. BASE<br/>3. EMITTER</p>               | <p>STYLE 18:<br/>PIN 1. ANODE<br/>2. CATHODE<br/>3. NOT CONNECTED</p>      | <p>STYLE 19:<br/>PIN 1. GATE<br/>2. ANODE<br/>3. CATHODE</p>              | <p>STYLE 20:<br/>PIN 1. NOT CONNECTED<br/>2. CATHODE<br/>3. ANODE</p> |
| <p>STYLE 21:<br/>PIN 1. COLLECTOR<br/>2. EMITTER<br/>3. BASE</p>            | <p>STYLE 22:<br/>PIN 1. SOURCE<br/>2. GATE<br/>3. DRAIN</p>                    | <p>STYLE 23:<br/>PIN 1. GATE<br/>2. SOURCE<br/>3. DRAIN</p>                | <p>STYLE 24:<br/>PIN 1. EMITTER<br/>2. COLLECTOR/ANODE<br/>3. CATHODE</p> | <p>STYLE 25:<br/>PIN 1. MT 1<br/>2. GATE<br/>3. MT 2</p>              |
| <p>STYLE 26:<br/>PIN 1. V<sub>CC</sub><br/>2. GROUND 2<br/>3. OUTPUT</p>    | <p>STYLE 27:<br/>PIN 1. MT<br/>2. SUBSTRATE<br/>3. MT</p>                      | <p>STYLE 28:<br/>PIN 1. CATHODE<br/>2. ANODE<br/>3. GATE</p>               | <p>STYLE 29:<br/>PIN 1. NOT CONNECTED<br/>2. ANODE<br/>3. CATHODE</p>     | <p>STYLE 30:<br/>PIN 1. DRAIN<br/>2. GATE<br/>3. SOURCE</p>           |
| <p>STYLE 31:<br/>PIN 1. GATE<br/>2. DRAIN<br/>3. SOURCE</p>                 | <p>STYLE 32:<br/>PIN 1. BASE<br/>2. COLLECTOR<br/>3. EMITTER</p>               | <p>STYLE 33:<br/>PIN 1. RETURN<br/>2. INPUT<br/>3. OUTPUT</p>              | <p>STYLE 34:<br/>PIN 1. INPUT<br/>2. GROUND<br/>3. LOGIC</p>              | <p>STYLE 35:<br/>PIN 1. GATE<br/>2. COLLECTOR<br/>3. EMITTER</p>      |

|                         |                              |   |
|-------------------------|------------------------------|---|
| <b>DOCUMENT NUMBER:</b> | <b>98AON52857E</b>           | Electronic versions are uncontrolled except when accessed directly from the Document Repository.<br>Printed versions are uncontrolled except when stamped "CONTROLLED COPY" in red. |
| <b>DESCRIPTION:</b>     | <b>TO-92 (TO-226) 1 WATT</b> | <b>PAGE 2 OF 2</b>  |

ON Semiconductor and  are trademarks of Semiconductor Components Industries, LLC dba ON Semiconductor or its subsidiaries in the United States and/or other countries. ON Semiconductor reserves the right to make changes without further notice to any products herein. ON Semiconductor makes no warranty, representation or guarantee regarding the suitability of its products for any particular purpose, nor does ON Semiconductor assume any liability arising out of the application or use of any product or circuit, and specifically disclaims any and all liability, including without limitation special, consequential or incidental damages. ON Semiconductor does not convey any license under its patent rights nor the rights of others.

# MECHANICAL CASE OUTLINE

## PACKAGE DIMENSIONS

ON Semiconductor®



SCALE 2:1

### SOT-89, 3 LEAD CASE 528AG ISSUE 0

DATE 04 MAR 2014

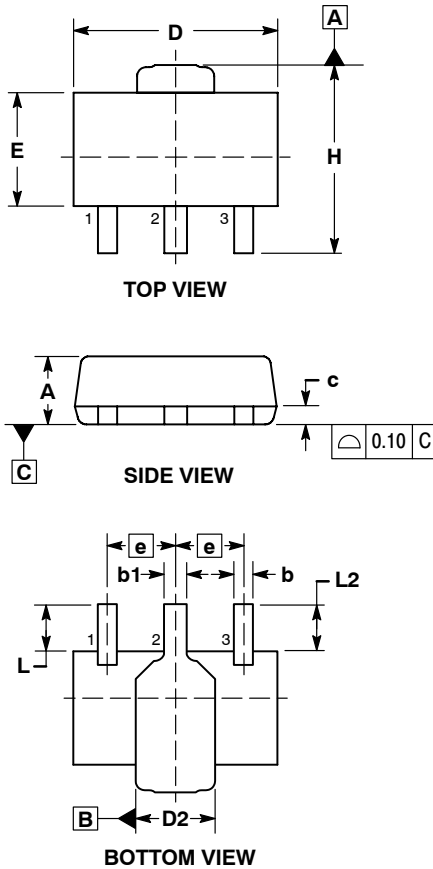

NOTES:

1. DIMENSIONING AND TOLERANCING PER ASME Y14.5M, 1994.
2. CONTROLLING DIMENSION: MILLIMETERS.
3. LEAD THICKNESS INCLUDES LEAD FINISH.
4. DIMENSIONS D AND E DO NOT INCLUDE MOLD FLASH, PROTRUSIONS, OR GATE BURRS.
5. DIMENSIONS L, L2, D2, AND H ARE MEASURED AT DATUM PLANE C.
6. CENTER LEAD CONTOUR MAY VARY WITHIN THE REGION DEFINED BY DIMENSION E.
7. DIMENSION D2 IS DEFINED AT ITS WIDEST POINT.

| MILLIMETERS |          |      |
|-------------|----------|------|
| DIM         | MIN      | MAX  |
| A           | 1.40     | 1.60 |
| b           | 0.38     | 0.47 |
| b1          | 0.46     | 0.55 |
| c           | 0.40     | 0.44 |
| D           | 4.40     | 4.60 |
| D2          | 1.60     | 1.90 |
| E           | 2.40     | 2.60 |
| e           | 1.50 BSC |      |
| H           | 4.05     | 4.25 |
| L           | 0.89     | 1.20 |

### GENERIC MARKING DIAGRAM\*

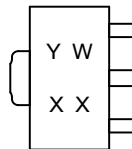

- Y = Year
- W = Work Week
- XX = Specific Device Code

\*This information is generic. Please refer to device data sheet for actual part marking. Pb-Free indicator, "G", may or not be present.

### RECOMMENDED MOUNTING FOOTPRINT\*

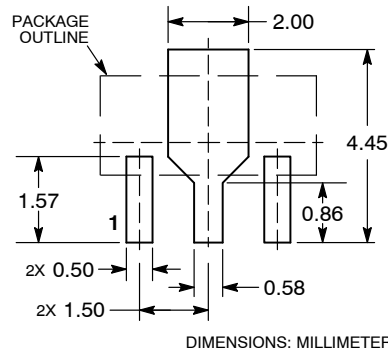

\*For additional information on our Pb-Free strategy and soldering details, please download the ON Semiconductor Soldering and Mounting Techniques Reference Manual, SOLDERRM/D.

|                         |                       |  |
|-------------------------|-----------------------|--|
| <b>DOCUMENT NUMBER:</b> | <b>98AON82692F</b>    | Electronic versions are uncontrolled except when accessed directly from the Document Repository. Printed versions are uncontrolled except when stamped "CONTROLLED COPY" in red. |
| <b>DESCRIPTION:</b>     | <b>SOT-89, 3 LEAD</b> | <b>PAGE 1 OF 1</b>   |

ON Semiconductor and are trademarks of Semiconductor Components Industries, LLC dba ON Semiconductor or its subsidiaries in the United States and/or other countries. ON Semiconductor reserves the right to make changes without further notice to any products herein. ON Semiconductor makes no warranty, representation or guarantee regarding the suitability of its products for any particular purpose, nor does ON Semiconductor assume any liability arising out of the application or use of any product or circuit, and specifically disclaims any and all liability, including without limitation special, consequential or incidental damages. ON Semiconductor does not convey any license under its patent rights nor the rights of others.

# MECHANICAL CASE OUTLINE PACKAGE DIMENSIONS

ON Semiconductor®



SCALE 1:1

SOIC-8 NB  
CASE 751-07  
ISSUE AK

DATE 16 FEB 2011



- NOTES:
1. DIMENSIONING AND TOLERANCING PER ANSI Y14.5M, 1982.
  2. CONTROLLING DIMENSION: MILLIMETER.
  3. DIMENSION A AND B DO NOT INCLUDE MOLD PROTRUSION.
  4. MAXIMUM MOLD PROTRUSION 0.15 (0.006) PER SIDE.
  5. DIMENSION D DOES NOT INCLUDE DAMBAR PROTRUSION. ALLOWABLE DAMBAR PROTRUSION SHALL BE 0.127 (0.005) TOTAL IN EXCESS OF THE D DIMENSION AT MAXIMUM MATERIAL CONDITION.
  6. 751-01 THRU 751-06 ARE OBSOLETE. NEW STANDARD IS 751-07.

| DIM | MILLIMETERS |      | INCHES    |       |
|-----|-------------|------|-----------|-------|
|     | MIN         | MAX  | MIN       | MAX   |
| A   | 4.80        | 5.00 | 0.189     | 0.197 |
| B   | 3.80        | 4.00 | 0.150     | 0.157 |
| C   | 1.35        | 1.75 | 0.053     | 0.069 |
| D   | 0.33        | 0.51 | 0.013     | 0.020 |
| G   | 1.27 BSC    |      | 0.050 BSC |       |
| H   | 0.10        | 0.25 | 0.004     | 0.010 |
| J   | 0.19        | 0.25 | 0.007     | 0.010 |
| K   | 0.40        | 1.27 | 0.016     | 0.050 |
| M   | 0°          | 8°   | 0°        | 8°    |
| N   | 0.25        | 0.50 | 0.010     | 0.020 |
| S   | 5.80        | 6.20 | 0.228     | 0.244 |

### SOLDERING FOOTPRINT\*

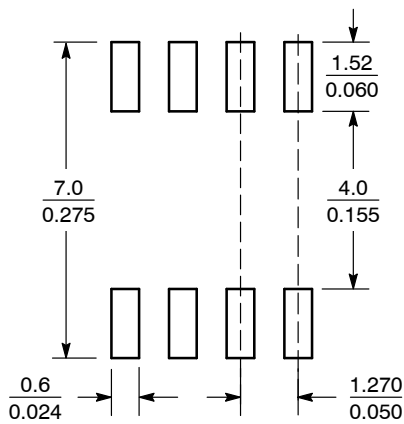

SCALE 6:1 (mm/inches)

\*For additional information on our Pb-Free strategy and soldering details, please download the ON Semiconductor Soldering and Mounting Techniques Reference Manual, SOLDERRM/D.

### GENERIC MARKING DIAGRAM\*

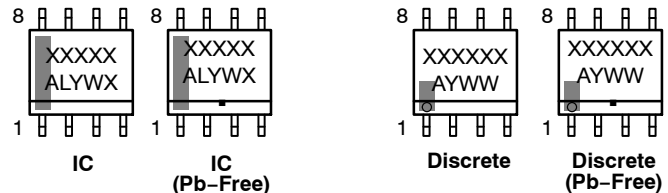

XXXXXX = Specific Device Code  
 A = Assembly Location  
 L = Wafer Lot  
 Y = Year  
 W = Work Week  
 ■ = Pb-Free Package

XXXXXX = Specific Device Code  
 A = Assembly Location  
 Y = Year  
 WW = Work Week  
 ■ = Pb-Free Package

\*This information is generic. Please refer to device data sheet for actual part marking. Pb-Free indicator, "G" or microdot "•", may or may not be present. Some products may not follow the Generic Marking.

STYLES ON PAGE 2

|                  |             |  |
|------------------|-------------|--|
| DOCUMENT NUMBER: | 98ASB42564B | Electronic versions are uncontrolled except when accessed directly from the Document Repository. Printed versions are uncontrolled except when stamped "CONTROLLED COPY" in red. |
| DESCRIPTION:     | SOIC-8 NB   | PAGE 1 OF 2  |

ON Semiconductor and ON are trademarks of Semiconductor Components Industries, LLC dba ON Semiconductor or its subsidiaries in the United States and/or other countries. ON Semiconductor reserves the right to make changes without further notice to any products herein. ON Semiconductor makes no warranty, representation or guarantee regarding the suitability of its products for any particular purpose, nor does ON Semiconductor assume any liability arising out of the application or use of any product or circuit, and specifically disclaims any and all liability, including without limitation special, consequential or incidental damages. ON Semiconductor does not convey any license under its patent rights nor the rights of others.



**SOIC-8 NB**  
**CASE 751-07**  
**ISSUE AK**

DATE 16 FEB 2011

- |  |   |   |   |
|--|---|---|---|
| <p><b>STYLE 1:</b><br/> PIN 1. EMITTER<br/> 2. COLLECTOR<br/> 3. COLLECTOR<br/> 4. EMITTER<br/> 5. EMITTER<br/> 6. BASE<br/> 7. BASE<br/> 8. EMITTER</p>   | <p><b>STYLE 2:</b><br/> PIN 1. COLLECTOR, DIE, #1<br/> 2. COLLECTOR, #1<br/> 3. COLLECTOR, #2<br/> 4. COLLECTOR, #2<br/> 5. BASE, #2<br/> 6. EMITTER, #2<br/> 7. BASE, #1<br/> 8. EMITTER, #1</p>               | <p><b>STYLE 3:</b><br/> PIN 1. DRAIN, DIE #1<br/> 2. DRAIN, #1<br/> 3. DRAIN, #2<br/> 4. DRAIN, #2<br/> 5. GATE, #2<br/> 6. SOURCE, #2<br/> 7. GATE, #1<br/> 8. SOURCE, #1</p>                            | <p><b>STYLE 4:</b><br/> PIN 1. ANODE<br/> 2. ANODE<br/> 3. ANODE<br/> 4. ANODE<br/> 5. ANODE<br/> 6. ANODE<br/> 7. ANODE<br/> 8. COMMON CATHODE</p>   |
| <p><b>STYLE 5:</b><br/> PIN 1. DRAIN<br/> 2. DRAIN<br/> 3. DRAIN<br/> 4. DRAIN<br/> 5. GATE<br/> 6. GATE<br/> 7. SOURCE<br/> 8. SOURCE</p>   | <p><b>STYLE 6:</b><br/> PIN 1. SOURCE<br/> 2. DRAIN<br/> 3. DRAIN<br/> 4. SOURCE<br/> 5. SOURCE<br/> 6. GATE<br/> 7. GATE<br/> 8. SOURCE</p>  | <p><b>STYLE 7:</b><br/> PIN 1. INPUT<br/> 2. EXTERNAL BYPASS<br/> 3. THIRD STAGE SOURCE<br/> 4. GROUND<br/> 5. DRAIN<br/> 6. GATE 3<br/> 7. SECOND STAGE Vd<br/> 8. FIRST STAGE Vd</p>                    | <p><b>STYLE 8:</b><br/> PIN 1. COLLECTOR, DIE #1<br/> 2. BASE, #1<br/> 3. BASE, #2<br/> 4. COLLECTOR, #2<br/> 5. COLLECTOR, #2<br/> 6. EMITTER, #2<br/> 7. EMITTER, #1<br/> 8. COLLECTOR, #1</p>                              |
| <p><b>STYLE 9:</b><br/> PIN 1. EMITTER, COMMON<br/> 2. COLLECTOR, DIE #1<br/> 3. COLLECTOR, DIE #2<br/> 4. EMITTER, COMMON<br/> 5. EMITTER, COMMON<br/> 6. BASE, DIE #2<br/> 7. BASE, DIE #1<br/> 8. EMITTER, COMMON</p> | <p><b>STYLE 10:</b><br/> PIN 1. GROUND<br/> 2. BIAS 1<br/> 3. OUTPUT<br/> 4. GROUND<br/> 5. GROUND<br/> 6. BIAS 2<br/> 7. INPUT<br/> 8. GROUND</p>  | <p><b>STYLE 11:</b><br/> PIN 1. SOURCE 1<br/> 2. GATE 1<br/> 3. SOURCE 2<br/> 4. GATE 2<br/> 5. DRAIN 2<br/> 6. DRAIN 2<br/> 7. DRAIN 1<br/> 8. DRAIN 1</p>   | <p><b>STYLE 12:</b><br/> PIN 1. SOURCE<br/> 2. SOURCE<br/> 3. SOURCE<br/> 4. GATE<br/> 5. DRAIN<br/> 6. DRAIN<br/> 7. DRAIN<br/> 8. DRAIN</p>   |
| <p><b>STYLE 13:</b><br/> PIN 1. N.C.<br/> 2. SOURCE<br/> 3. SOURCE<br/> 4. GATE<br/> 5. DRAIN<br/> 6. DRAIN<br/> 7. DRAIN<br/> 8. DRAIN</p>  | <p><b>STYLE 14:</b><br/> PIN 1. N-SOURCE<br/> 2. N-GATE<br/> 3. P-SOURCE<br/> 4. P-GATE<br/> 5. P-DRAIN<br/> 6. P-DRAIN<br/> 7. N-DRAIN<br/> 8. N-DRAIN</p>   | <p><b>STYLE 15:</b><br/> PIN 1. ANODE 1<br/> 2. ANODE 1<br/> 3. ANODE 1<br/> 4. ANODE 1<br/> 5. CATHODE, COMMON<br/> 6. CATHODE, COMMON<br/> 7. CATHODE, COMMON<br/> 8. CATHODE, COMMON</p>               | <p><b>STYLE 16:</b><br/> PIN 1. EMITTER, DIE #1<br/> 2. BASE, DIE #1<br/> 3. EMITTER, DIE #2<br/> 4. BASE, DIE #2<br/> 5. COLLECTOR, DIE #2<br/> 6. COLLECTOR, DIE #2<br/> 7. COLLECTOR, DIE #1<br/> 8. COLLECTOR, DIE #1</p> |
| <p><b>STYLE 17:</b><br/> PIN 1. VCC<br/> 2. V2OUT<br/> 3. V1OUT<br/> 4. TXE<br/> 5. RXE<br/> 6. VEE<br/> 7. GND<br/> 8. ACC</p>  | <p><b>STYLE 18:</b><br/> PIN 1. ANODE<br/> 2. ANODE<br/> 3. SOURCE<br/> 4. GATE<br/> 5. DRAIN<br/> 6. DRAIN<br/> 7. CATHODE<br/> 8. CATHODE</p>   | <p><b>STYLE 19:</b><br/> PIN 1. SOURCE 1<br/> 2. GATE 1<br/> 3. SOURCE 2<br/> 4. GATE 2<br/> 5. DRAIN 2<br/> 6. MIRROR 2<br/> 7. DRAIN 1<br/> 8. MIRROR 1</p>   | <p><b>STYLE 20:</b><br/> PIN 1. SOURCE (N)<br/> 2. GATE (N)<br/> 3. SOURCE (P)<br/> 4. GATE (P)<br/> 5. DRAIN<br/> 6. DRAIN<br/> 7. DRAIN<br/> 8. DRAIN</p>   |
| <p><b>STYLE 21:</b><br/> PIN 1. CATHODE 1<br/> 2. CATHODE 2<br/> 3. CATHODE 3<br/> 4. CATHODE 4<br/> 5. CATHODE 5<br/> 6. COMMON ANODE<br/> 7. COMMON ANODE<br/> 8. CATHODE 6</p>  | <p><b>STYLE 22:</b><br/> PIN 1. I/O LINE 1<br/> 2. COMMON CATHODE/VCC<br/> 3. COMMON CATHODE/VCC<br/> 4. I/O LINE 3<br/> 5. COMMON ANODE/GND<br/> 6. I/O LINE 4<br/> 7. I/O LINE 5<br/> 8. COMMON ANODE/GND</p> | <p><b>STYLE 23:</b><br/> PIN 1. LINE 1 IN<br/> 2. COMMON ANODE/GND<br/> 3. COMMON ANODE/GND<br/> 4. LINE 2 IN<br/> 5. LINE 2 OUT<br/> 6. COMMON ANODE/GND<br/> 7. COMMON ANODE/GND<br/> 8. LINE 1 OUT</p> | <p><b>STYLE 24:</b><br/> PIN 1. BASE<br/> 2. EMITTER<br/> 3. COLLECTOR/ANODE<br/> 4. COLLECTOR/ANODE<br/> 5. CATHODE<br/> 6. CATHODE<br/> 7. COLLECTOR/ANODE<br/> 8. COLLECTOR/ANODE</p>                                      |
| <p><b>STYLE 25:</b><br/> PIN 1. VIN<br/> 2. N/C<br/> 3. REXT<br/> 4. GND<br/> 5. IOUT<br/> 6. IOUT<br/> 7. IOUT<br/> 8. IOUT</p>   | <p><b>STYLE 26:</b><br/> PIN 1. GND<br/> 2. dv/dt<br/> 3. ENABLE<br/> 4. ILIMIT<br/> 5. SOURCE<br/> 6. SOURCE<br/> 7. SOURCE<br/> 8. VCC</p>  | <p><b>STYLE 27:</b><br/> PIN 1. ILIMIT<br/> 2. OVLO<br/> 3. UVLO<br/> 4. INPUT+<br/> 5. SOURCE<br/> 6. SOURCE<br/> 7. SOURCE<br/> 8. DRAIN</p>  | <p><b>STYLE 28:</b><br/> PIN 1. SW_TO_GND<br/> 2. DASIC OFF<br/> 3. DASIC_SW_DET<br/> 4. GND<br/> 5. V_MON<br/> 6. VBULK<br/> 7. VBULK<br/> 8. VIN</p>  |
| <p><b>STYLE 29:</b><br/> PIN 1. BASE, DIE #1<br/> 2. EMITTER, #1<br/> 3. BASE, #2<br/> 4. EMITTER, #2<br/> 5. COLLECTOR, #2<br/> 6. COLLECTOR, #2<br/> 7. COLLECTOR, #1<br/> 8. COLLECTOR, #1</p>                        | <p><b>STYLE 30:</b><br/> PIN 1. DRAIN 1<br/> 2. DRAIN 1<br/> 3. GATE 2<br/> 4. SOURCE 2<br/> 5. SOURCE 1/DRAIN 2<br/> 6. SOURCE 1/DRAIN 2<br/> 7. SOURCE 1/DRAIN 2<br/> 8. GATE 1</p>                           |   |   |

|                         |                    |   |
|-------------------------|--------------------|---|
| <b>DOCUMENT NUMBER:</b> | <b>98ASB42564B</b> | Electronic versions are uncontrolled except when accessed directly from the Document Repository.<br>Printed versions are uncontrolled except when stamped "CONTROLLED COPY" in red. |
| <b>DESCRIPTION:</b>     | <b>SOIC-8 NB</b>   | <b>PAGE 2 OF 2</b>  |

ON Semiconductor and  are trademarks of Semiconductor Components Industries, LLC dba ON Semiconductor or its subsidiaries in the United States and/or other countries. ON Semiconductor reserves the right to make changes without further notice to any products herein. ON Semiconductor makes no warranty, representation or guarantee regarding the suitability of its products for any particular purpose, nor does ON Semiconductor assume any liability arising out of the application or use of any product or circuit, and specifically disclaims any and all liability, including without limitation special, consequential or incidental damages. ON Semiconductor does not convey any license under its patent rights nor the rights of others.

ON Semiconductor and  are trademarks of Semiconductor Components Industries, LLC dba ON Semiconductor or its subsidiaries in the United States and/or other countries. ON Semiconductor owns the rights to a number of patents, trademarks, copyrights, trade secrets, and other intellectual property. A listing of ON Semiconductor's product/patent coverage may be accessed at [www.onsemi.com/site/pdf/Patent-Marking.pdf](http://www.onsemi.com/site/pdf/Patent-Marking.pdf). ON Semiconductor reserves the right to make changes without further notice to any products herein. ON Semiconductor makes no warranty, representation or guarantee regarding the suitability of its products for any particular purpose, nor does ON Semiconductor assume any liability arising out of the application or use of any product or circuit, and specifically disclaims any and all liability, including without limitation special, consequential or incidental damages. Buyer is responsible for its products and applications using ON Semiconductor products, including compliance with all laws, regulations and safety requirements or standards, regardless of any support or applications information provided by ON Semiconductor. "Typical" parameters which may be provided in ON Semiconductor data sheets and/or specifications can and do vary in different applications and actual performance may vary over time. All operating parameters, including "Typicals" must be validated for each customer application by customer's technical experts. ON Semiconductor does not convey any license under its patent rights nor the rights of others. ON Semiconductor products are not designed, intended, or authorized for use as a critical component in life support systems or any FDA Class 3 medical devices or medical devices with a same or similar classification in a foreign jurisdiction or any devices intended for implantation in the human body. Should Buyer purchase or use ON Semiconductor products for any such unintended or unauthorized application, Buyer shall indemnify and hold ON Semiconductor and its officers, employees, subsidiaries, affiliates, and distributors harmless against all claims, costs, damages, and expenses, and reasonable attorney fees arising out of, directly or indirectly, any claim of personal injury or death associated with such unintended or unauthorized use, even if such claim alleges that ON Semiconductor was negligent regarding the design or manufacture of the part. ON Semiconductor is an Equal Opportunity/Affirmative Action Employer. This literature is subject to all applicable copyright laws and is not for resale in any manner.

## PUBLICATION ORDERING INFORMATION

### LITERATURE FULFILLMENT:

Email Requests to: [orderlit@onsemi.com](mailto:orderlit@onsemi.com)

ON Semiconductor Website: [www.onsemi.com](http://www.onsemi.com)

### TECHNICAL SUPPORT

North American Technical Support:  
Voice Mail: 1 800-282-9855 Toll Free USA/Canada  
Phone: 011 421 33 790 2910

### Europe, Middle East and Africa Technical Support:

Phone: 00421 33 790 2910

For additional information, please contact your local Sales Representative