

Three-Terminal Low Current Positive Voltage Regulators

BL78XXB

FEATURES

- Internal Thermal Overload Protection.
- Internal Short Circuit Current Limiting.
- Output Current up to 1.5A.
- Satisfies IEC-65 Specification.
(International Electrotechnical Commission).

HF

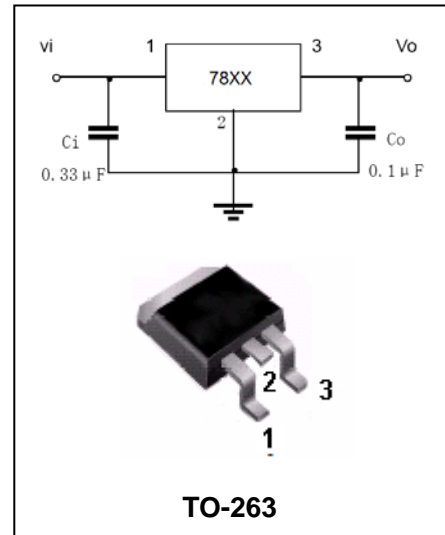

APPLICATIONS

- Three-terminal positive voltage regulator.

Ordering Information

Part Number	Package	Shipping	Marking Code
BL7805B	TO-263	50pcs / Tube or 800pcs / Tape & Reel	7805B
BL7806B	TO-263	50pcs / Tube or 800pcs / Tape & Reel	7806B
BL7807B	TO-263	50pcs / Tube or 800pcs / Tape & Reel	7807B
BL7808B	TO-263	50pcs / Tube or 800pcs / Tape & Reel	7808B
BL7809B	TO-263	50pcs / Tube or 800pcs / Tape & Reel	7809B
BL7810B	TO-263	50pcs / Tube or 800pcs / Tape & Reel	7810B
BL7812B	TO-263	50pcs / Tube or 800pcs / Tape & Reel	7812B
BL7815B	TO-263	50pcs / Tube or 800pcs / Tape & Reel	7815B
BL7818B	TO-263	50pcs / Tube or 800pcs / Tape & Reel	7818B
BL7820B	TO-263	50pcs / Tube or 800pcs / Tape & Reel	7820B
BL7824B	TO-263	50pcs / Tube or 800pcs / Tape & Reel	7824B

Three-Terminal Low Current Positive Voltage Regulators BL78XXB

MAXIMUM RATING @ $T_a=25^\circ\text{C}$ unless otherwise specified

Symbol	Parameter	Value	Units
V_I	Input voltage	(7805--7815)	35
		(7818--7824)	40
P_D	Power dissipation-1	(No Heatsink)	1.9
	Power dissipation-2	(Infinite Heatsink)	30
T_J	Operating junction temperature	-40 to +125	$^\circ\text{C}$
T_{STG}	Storage temperature range	-55 to +150	$^\circ\text{C}$

ELECTRICAL CHARACTERISTICS ($V_{IN}=10\text{V}, I_o=500\text{mA}, 0^\circ\text{C}\leq T_j\leq 125^\circ\text{C}$)

Parameter	Symbol	Test conditions	BL7805B			UNIT
			MIN	TYP	MAX	
Output voltage	V_O	$T_j=25^\circ\text{C}, I_o=100\text{mA}$	4.8	5.0	5.2	V
Load regulation	Reg_{load}	$T_j=25^\circ\text{C}, I_o=5\text{mA}-1.5\text{A}$		15	100	mV
		$T_j=25^\circ\text{C}, I_o=250\text{mA}-750\text{mA}$		5	50	
Input regulation	$\text{Reg}_{\text{Input}}$	$T_j=25^\circ\text{C}, 7\text{V}\leq V_i\leq 25\text{V}$		3	100	mV
		$T_j=25^\circ\text{C}, 8\text{V}\leq V_i\leq 12\text{V}$		1	50	
Output voltage	V_O	$7.0\text{V}\leq V_i\leq 20\text{V}$	4.75		5.25	V
Quiescent Current	I_B	$T_j=25^\circ\text{C}, I_o=5\text{mA}$		4.2	8.0	mA
Quiescent Current Change	ΔI_B	$7.0\text{V}\leq V_i\leq 25\text{V}$			1.3	mA
Output noise voltage	V_N	$T_a=25^\circ\text{C}, 10\text{Hz}\leq f\leq 100\text{KHz}$		50		μV
Ripple rejection	RR	$8\text{V}\leq V_i\leq 18\text{V}, f=120\text{Hz}$	62	78		dB
Dropout voltage	V_D	$T_j=25^\circ\text{C}, I_o=1.0\text{A}$		2.0		V
Short Circuit Current Limit	I_{SC}	$T_j=25^\circ\text{C}$		1.6		A
Average temperature coefficient Of Output voltage	TC_{V_O}	$0^\circ\text{C}\leq T_j\leq 125^\circ\text{C}, I_o=5\text{mA}$		-0.6		mv/ $^\circ\text{C}$

Three-Terminal Low Current Positive Voltage Regulators BL78XXB

ELECTRICAL CHARACTERISTICS ($V_{IN}=11V, I_O=500mA, 0^{\circ}C \leq T_j \leq 125^{\circ}C$)

Parameter	Symbol	Test conditions	BL7806B			UNIT
			MIN	TYP	MAX	
Output voltage	V_O	$T_j=25^{\circ}C, I_O=100mA$	5.75	6.0	6.25	V
Load regulation	Reg_{load}	$T_j=25^{\circ}C, I_O=5mA-1.5A$ $T_j=25^{\circ}C, I_O=250mA-750mA$		15 5	120 60	mV
Input regulation	Reg_{Input}	$T_j=25^{\circ}C, 8V \leq V_i \leq 25V$ $T_j=25^{\circ}C, 9V \leq V_i \leq 13V$		4 2	120 60	mV
Output voltage	V_O	$8.0V \leq V_i \leq 21V$	5.7		6.3	V
Quiescent Current	I_B	$T_j=25^{\circ}C, I_O=5mA$		4.3	8.0	mA
Quiescent Current Change	ΔI_B	$8.0V \leq V_i \leq 25V$			1.3	mA
Output noise voltage	V_N	$T_a=25^{\circ}C, 10Hz \leq f \leq 100KHz$		55		μV
Ripple rejection	RR	$9V \leq V_i \leq 19V, f=120Hz$	61	77		dB
Dropout voltage	V_D	$T_j=25^{\circ}C, I_O=1.0A$		2.0		V
Short Circuit Current Limit	I_{SC}	$T_j=25^{\circ}C$		1.5		A
Average temperature coefficient Of Output voltage	TC_{VO}	$0^{\circ}C \leq T_j \leq 125^{\circ}C, I_O=5mA$		-0.7		mv/ $^{\circ}C$

ELECTRICAL CHARACTERISTICS ($V_{IN}=12V, I_O=500mA, 0^{\circ}C \leq T_j \leq 125^{\circ}C$)

Parameter	Symbol	Test conditions	BL7807B			UNIT
			MIN	TYP	MAX	
Output voltage	V_O	$T_j=25^{\circ}C, I_O=100mA$	6.72	7.0	7.28	V
Load regulation	Reg_{load}	$T_j=25^{\circ}C, I_O=5mA-1.5A$ $T_j=25^{\circ}C, I_O=250mA-750mA$		15 5	140 70	mV
Input regulation	Reg_{Input}	$T_j=25^{\circ}C, 9V \leq V_i \leq 25V$ $T_j=25^{\circ}C, 10V \leq V_i \leq 14V$		5 2	140 70	mV
Output voltage	V_O	$9.0V \leq V_i \leq 22V$	6.65		7.35	V
Quiescent Current	I_B	$T_j=25^{\circ}C, I_O=5mA$		4.3	8.0	mA

Three-Terminal Low Current Positive Voltage Regulators BL78XXB

Quiescent Current Change	ΔI_B	$9.0V \leq V_i \leq 25V$			1.3	mA
Output noise voltage	V_N	$T_a = 25^\circ C, 10Hz \leq f \leq 100KHz$		60		μV
Ripple rejection	RR	$10V \leq V_i \leq 20V, f = 120Hz$	59	75		dB
Dropout voltage	V_D	$T_j = 25^\circ C, I_o = 1.0A$		2.0		V
Short Circuit Current Limit	I_{SC}	$T_j = 25^\circ C$		1.3		A
Average temperature coefficient Of Output voltage	TC_{V_O}	$0^\circ C \leq T_j \leq 125^\circ C, I_o = 5mA$		-0.8		$mv/^\circ C$

ELECTRICAL CHARACTERISTICS ($V_{IN} = 14V, I_o = 500mA, 0^\circ C \leq T_j \leq 125^\circ C$)

Parameter	Symbol	Test conditions	BL7808B			UNIT
			MIN	TYP	MAX	
Output voltage	V_O	$T_j = 25^\circ C, I_o = 100mA$	7.7	8.0	8.3	V
Load regulation	Reg_{load}	$T_j = 25^\circ C, I_o = 5mA - 1.5A$ $T_j = 25^\circ C, I_o = 250mA - 750mA$		12 4	160 80	mV
Input regulation	Reg_{Input}	$T_j = 25^\circ C, 10.5V \leq V_i \leq 25V$ $T_j = 25^\circ C, 11V \leq V_i \leq 17V$		6 2	160 80	mV
Output voltage	V_O	$10.5V \leq V_i \leq 23V$	7.6		8.4	V
Quiescent Current	I_B	$T_j = 25^\circ C, I_o = 5mA$		4.3	8.0	mA
Quiescent Current Change	ΔI_B	$10.5V \leq V_i \leq 25V$			1.0	mA
Output noise voltage	V_N	$T_a = 25^\circ C, 10Hz \leq f \leq 100KHz$		70		μV
Ripple rejection	RR	$11.5V \leq V_i \leq 21.5V, f = 120Hz$	58	74		dB
Dropout voltage	V_D	$T_j = 25^\circ C, I_o = 1.0A$		2.0		V
Short Circuit Current Limit	I_{SC}	$T_j = 25^\circ C$		1.1		A
Average temperature coefficient Of Output voltage	TC_{V_O}	$0^\circ C \leq T_j \leq 125^\circ C, I_o = 5mA$		-1.0		$mv/^\circ C$

Three-Terminal Low Current Positive Voltage Regulators BL78XXB

ELECTRICAL CHARACTERISTICS ($V_{IN}=15V, I_o=500mA, 0^{\circ}C \leq T_j \leq 125^{\circ}C$)

Parameter	Symbol	Test conditions	BL7809B			UNIT
			MIN	TYP	MAX	
Output voltage	V_O	$T_j=25^{\circ}C, I_o=100mA$	8.64	9.0	9.36	V
Load regulation	Reg_{load}	$T_j=25^{\circ}C, I_o=5mA-1.5A$ $T_j=25^{\circ}C, I_o=250mA-750mA$		12 4	180 90	mV
Input regulation	Reg_{Input}	$T_j=25^{\circ}C, 11.5V \leq V_i \leq 26V$ $T_j=25^{\circ}C, 13V \leq V_i \leq 19V$		7 2.5	180 90	mV
Output voltage	V_O	$11.5V \leq V_i \leq 26V$	8.55		9.45	V
Quiescent Current	I_B	$T_j=25^{\circ}C, I_o=5mA$		4.3	8.0	mA
Quiescent Current Change	ΔI_B	$11.5V \leq V_i \leq 26V$			1.0	mA
Output noise voltage	V_N	$T_a=25^{\circ}C, 10Hz \leq f \leq 100KHz$		75		μV
Ripple rejection	RR	$12.5V \leq V_i \leq 22.5V, f=120Hz$	56	72		dB
Dropout voltage	V_D	$T_j=25^{\circ}C, I_o=1.0A$		2.0		V
Short Circuit Current Limit	I_{SC}	$T_j=25^{\circ}C$		1.0		A
Average temperature coefficient Of Output voltage	TC_{VO}	$0^{\circ}C \leq T_j \leq 125^{\circ}C, I_o=5mA$		-1.1		mv/ $^{\circ}C$

ELECTRICAL CHARACTERISTICS ($V_{IN}=16V, I_o=500mA, 0^{\circ}C \leq T_j \leq 125^{\circ}C$)

Parameter	Symbol	Test conditions	BL7810B			UNIT
			MIN	TYP	MAX	
Output voltage	V_O	$T_j=25^{\circ}C, I_o=100mA$	9.6	10.0	10.4	V
Load regulation	Reg_{load}	$T_j=25^{\circ}C, I_o=5mA-1.5A$ $T_j=25^{\circ}C, I_o=250mA-750mA$		12 4	200 100	mV
Input regulation	Reg_{Input}	$T_j=25^{\circ}C, 12.5V \leq V_i \leq 27V$ $T_j=25^{\circ}C, 14V \leq V_i \leq 20V$		8 2.5	200 100	mV
Output voltage	V_O	$12.5V \leq V_i \leq 25V$	9.5		10.5	V
Quiescent Current	I_B	$T_j=25^{\circ}C, I_o=5mA$		4.3	8.0	mA

Three-Terminal Low Current Positive Voltage Regulators BL78XXB

Quiescent Current Change	ΔI_B	$12.5V \leq V_i \leq 27V$			1.0	mA
Output noise voltage	V_N	$T_a=25^\circ C, 10Hz \leq f \leq 100KHz$		80		μV
Ripple rejection	RR	$13.5V \leq V_i \leq 23.5V, f=120Hz$	55	72		dB
Dropout voltage	V_D	$T_j=25^\circ C, I_o=1.0A$		2.0		V
Short Circuit Current Limit	I_{SC}	$T_j=25^\circ C$		0.9		A
Average temperature coefficient Of Output voltage	TC_{VO}	$0^\circ C \leq T_j \leq 125^\circ C, I_o=5mA$		-1.3		$mv/^\circ C$

ELECTRICAL CHARACTERISTICS ($V_{IN}=19V, I_o=500mA, 0^\circ C \leq T_j \leq 125^\circ C$)

Parameter	Symbol	Test conditions	BL7812B			UNIT
			MIN	TYP	MAX	
Output voltage	V_O	$T_j=25^\circ C, I_o=100mA$	11.5	12.0	12.5	V
Load regulation	Reg_{load}	$T_j=25^\circ C, I_o=5mA-1.5A$ $T_j=25^\circ C, I_o=250mA-750mA$		12 4	240 120	mV
Input regulation	Reg_{Input}	$T_j=25^\circ C, 14.5V \leq V_i \leq 30V$ $T_j=25^\circ C, 16V \leq V_i \leq 22V$		10 3	240 120	mV
Output voltage	V_O	$14.5V \leq V_i \leq 27V$	11.4		12.6	V
Quiescent Current	I_B	$T_j=25^\circ C, I_o=5mA$		4.3	8.0	mA
Quiescent Current Change	ΔI_B	$14.5V \leq V_i \leq 30V$			1.0	mA
Output noise voltage	V_N	$T_a=25^\circ C, 10Hz \leq f \leq 100KHz$		90		μV
Ripple rejection	RR	$15V \leq V_i \leq 25V, f=120Hz$	55	71		dB
Dropout voltage	V_D	$T_j=25^\circ C, I_o=1.0A$		2.0		V
Short Circuit Current Limit	I_{SC}	$T_j=25^\circ C$		0.7		A
Average temperature coefficient Of Output voltage	TC_{VO}	$0^\circ C \leq T_j \leq 125^\circ C, I_o=5mA$		-1.6		$mv/^\circ C$

Three-Terminal Low Current Positive Voltage Regulators BL78XXB

ELECTRICAL CHARACTERISTICS ($V_{IN}=23V, I_o=500mA, 0^{\circ}C \leq T_j \leq 125^{\circ}C$)

Parameter	Symbol	Test conditions	BL7815B			UNIT
			MIN	TYP	MAX	
Output voltage	V_O	$T_j=25^{\circ}C, I_o=100mA$	14.4	15.0	15.6	V
Load regulation	Reg_{load}	$T_j=25^{\circ}C, I_o=5mA-1.5A$ $T_j=25^{\circ}C, I_o=250mA-750mA$		12 4	300 150	mV
Input regulation	Reg_{Input}	$T_j=25^{\circ}C, 17.5V \leq V_i \leq 30V$ $T_j=25^{\circ}C, 20V \leq V_i \leq 26V$		11 3	300 150	mV
Output voltage	V_O	$17.5V \leq V_i \leq 30V$	14.25		15.75	V
Quiescent Current	I_B	$T_j=25^{\circ}C, I_o=5mA$		4.4	8.0	mA
Quiescent Current Change	ΔI_B	$17.5V \leq V_i \leq 30V$			1.0	mA
Output noise voltage	V_N	$T_a=25^{\circ}C, 10Hz \leq f \leq 100KHz$		110		μV
Ripple rejection	RR	$18.5V \leq V_i \leq 28.5V, f=120Hz$	54	70		dB
Dropout voltage	V_D	$T_j=25^{\circ}C, I_o=1.0A$		2.0		V
Short Circuit Current Limit	I_{SC}	$T_j=25^{\circ}C$		0.5		A
Average temperature coefficient Of Output voltage	TC_{VO}	$0^{\circ}C \leq T_j \leq 125^{\circ}C, I_o=5mA$		-2.0		mv/ $^{\circ}C$

ELECTRICAL CHARACTERISTICS ($V_{IN}=27V, I_o=500mA, 0^{\circ}C \leq T_j \leq 125^{\circ}C$)

Parameter	Symbol	Test conditions	BL7818B			UNIT
			MIN	TYP	MAX	
Output voltage	V_O	$T_j=25^{\circ}C, I_o=100mA$	17.3	18.0	18.7	V
Load regulation	Reg_{load}	$T_j=25^{\circ}C, I_o=5mA-1.5A$ $T_j=25^{\circ}C, I_o=250mA-750mA$		12 4	360 180	mV
Input regulation	Reg_{Input}	$T_j=25^{\circ}C, 21V \leq V_i \leq 33V$ $T_j=25^{\circ}C, 24V \leq V_i \leq 30V$		13 4	360 180	mV
Output voltage	V_O	$21V \leq V_i \leq 33V$	17.1		18.9	V
Quiescent Current	I_B	$T_j=25^{\circ}C, I_o=5mA$		4.5	8.0	mA

Three-Terminal Low Current Positive Voltage Regulators BL78XXB

Quiescent Current Change	ΔI_B	$21V \leq V_i \leq 33V$			1.0	mA
Output noise voltage	V_N	$T_a = 25^\circ C, 10Hz \leq f \leq 100KHz$		125		μV
Ripple rejection	RR	$22V \leq V_i \leq 32V, f = 120Hz$	52	68		dB
Dropout voltage	V_D	$T_j = 25^\circ C, I_o = 1.0A$		2.0		V
Short Circuit Current Limit	I_{SC}	$T_j = 25^\circ C$		0.4		A
Average temperature coefficient Of Output voltage	TC_{VO}	$0^\circ C \leq T_j \leq 125^\circ C, I_o = 5mA$		-2.5		mv/ $^\circ C$

ELECTRICAL CHARACTERISTICS ($V_{IN} = 29V, I_o = 500mA, 0^\circ C \leq T_j \leq 125^\circ C$)

Parameter	Symbol	Test conditions	BL7820B			UNIT
			MIN	TYP	MAX	
Output voltage	V_O	$T_j = 25^\circ C, I_o = 100mA$	19.2	20.0	20.8	V
Load regulation	Reg_{load}	$T_j = 25^\circ C, I_o = 5mA - 1.5A$ $T_j = 25^\circ C, I_o = 250mA - 750mA$		12 4	400 200	mV
Input regulation	Reg_{Input}	$T_j = 25^\circ C, 23V \leq V_i \leq 35V$ $T_j = 25^\circ C, 26V \leq V_i \leq 32V$		15 5	400 200	mV
Output voltage	V_O	$23V \leq V_i \leq 35V$	19.0		21.0	V
Quiescent Current	I_B	$T_j = 25^\circ C, I_o = 5mA$		4.6	8.0	mA
Quiescent Current Change	ΔI_B	$23V \leq V_i \leq 35V$			1.0	mA
Output noise voltage	V_N	$T_a = 25^\circ C, 10Hz \leq f \leq 100KHz$		135		μV
Ripple rejection	RR	$24V \leq V_i \leq 34V, f = 120Hz$	50	66		dB
Dropout voltage	V_D	$T_j = 25^\circ C, I_o = 1.0A$		2.0		V
Short Circuit Current Limit	I_{SC}	$T_j = 25^\circ C$		0.4		A
Average temperature coefficient Of Output voltage	TC_{VO}	$0^\circ C \leq T_j \leq 125^\circ C, I_o = 5mA$		-3.0		mv/ $^\circ C$

Three-Terminal Low Current Positive Voltage Regulators BL78XXB

ELECTRICAL CHARACTERISTICS ($V_{IN}=33V, I_O=500mA, 0^{\circ}C \leq T_j \leq 125^{\circ}C$)

Parameter	Symbol	Test conditions	BL7824B			UNIT
			MIN	TYP	MAX	
Output voltage	V_O	$T_j=25^{\circ}C, I_O=100mA$	23.0	24.0	25.0	V
Load regulation	Reg_{load}	$T_j=25^{\circ}C, I_O=5mA-1.5A$ $T_j=25^{\circ}C, I_O=250mA-750mA$		12 4	480 240	mV
Input regulation	Reg_{Input}	$T_j=25^{\circ}C, 27V \leq V_i \leq 38V$ $T_j=25^{\circ}C, 30V \leq V_i \leq 36V$		18 6	480 240	mV
Output voltage	V_O	$27V \leq V_i \leq 38V$	22.8		25.2	V
Quiescent Current	I_B	$T_j=25^{\circ}C, I_O=5mA$		4.6	8.0	mA
Quiescent Current Change	ΔI_B	$27V \leq V_i \leq 38V$			1.0	mA
Output noise voltage	V_N	$T_a=25^{\circ}C, 10Hz \leq f \leq 100KHz$		150		μV
Ripple rejection	RR	$28V \leq V_i \leq 38V, f=120Hz$	50	66		dB
Dropout voltage	V_D	$T_j=25^{\circ}C, I_O=1.0A$		2.0		V
Short Circuit Current Limit	I_{sc}	$T_j=25^{\circ}C$		0.3		A
Average temperature coefficient Of Output voltage	TC_{VO}	$0^{\circ}C \leq T_j \leq 125^{\circ}C, I_O=5mA$		-3.5		mv/ $^{\circ}C$

Three-Terminal Low Current Positive Voltage Regulators

BL78XXB

TYPICAL CHARACTERISTICS @ $T_a=25^\circ\text{C}$ unless otherwise specified

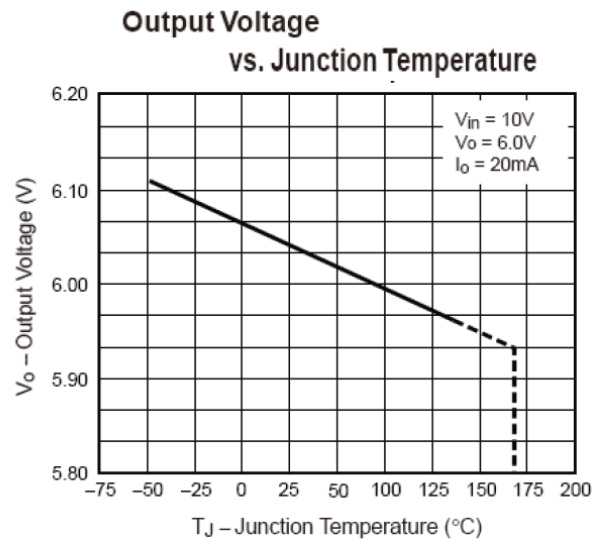
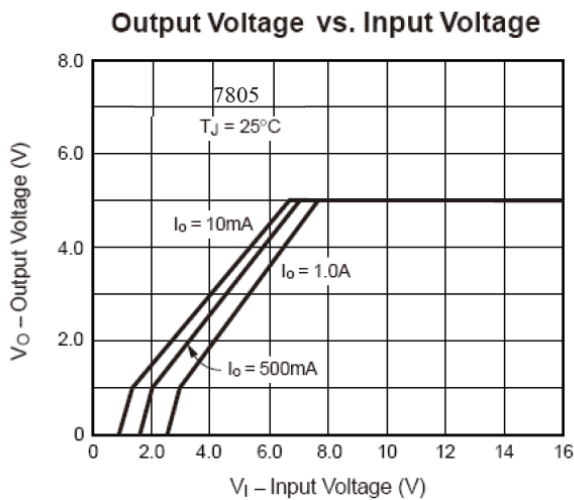
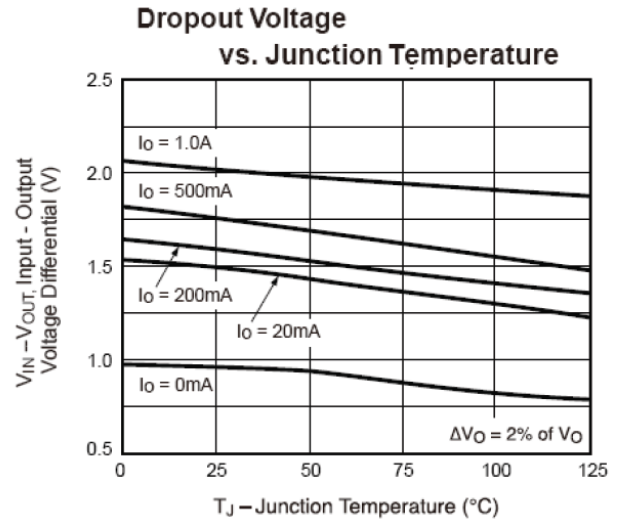
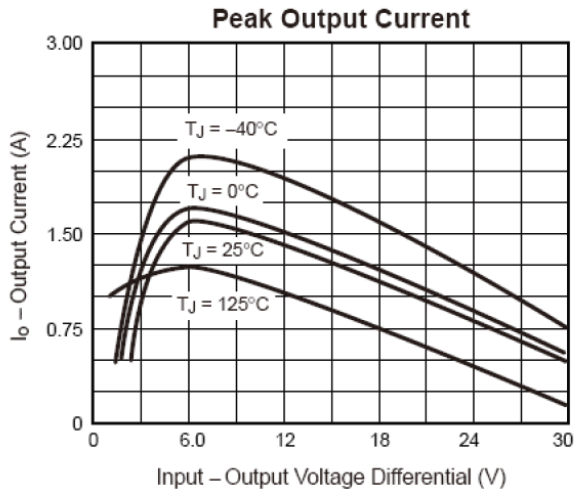

Three-Terminal Low Current Positive Voltage Regulators

BL78XXB

PACKAGE OUTLINE

Plastic surface mounted package

Plastic surface mounted package

TO-263

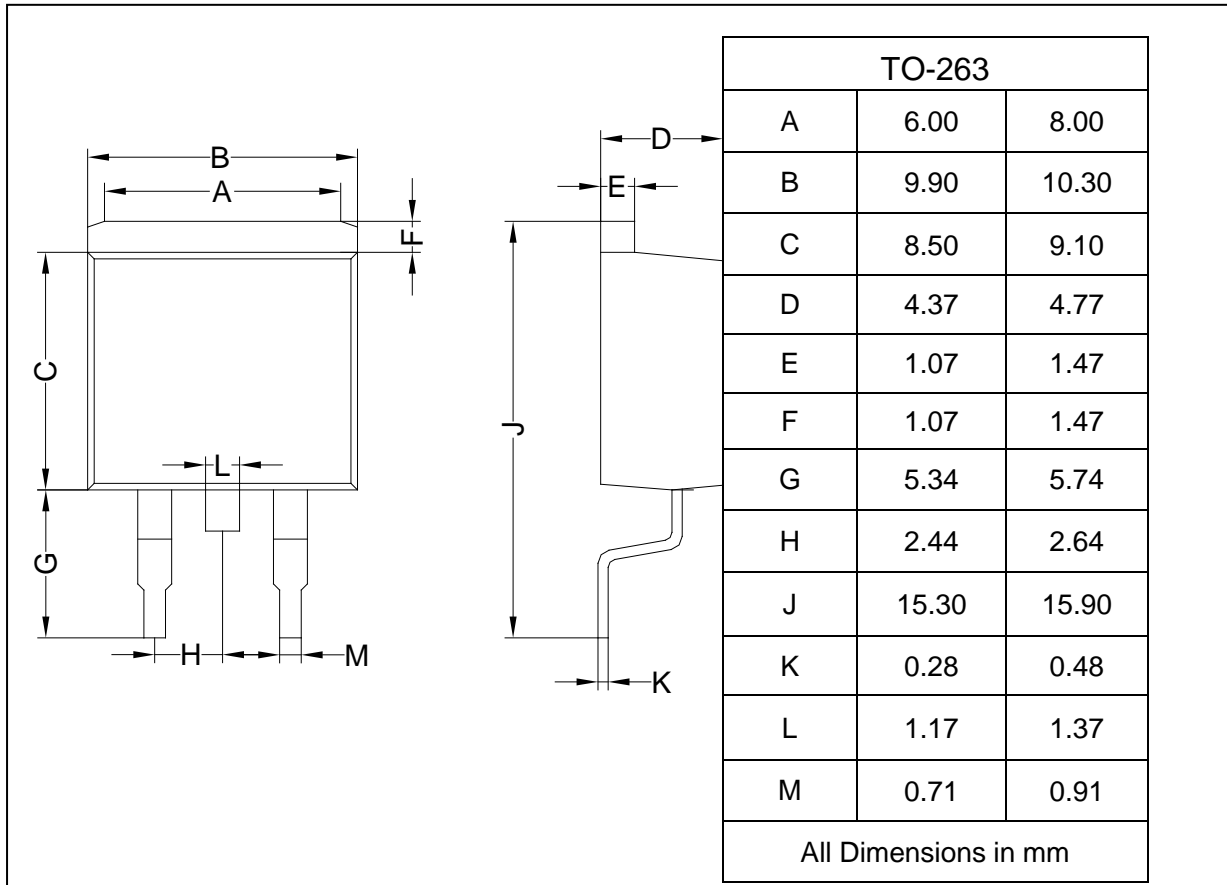

Three-Terminal Low Current Positive Voltage Regulators

BL78XXB

SOLDERING FOOTPRINT

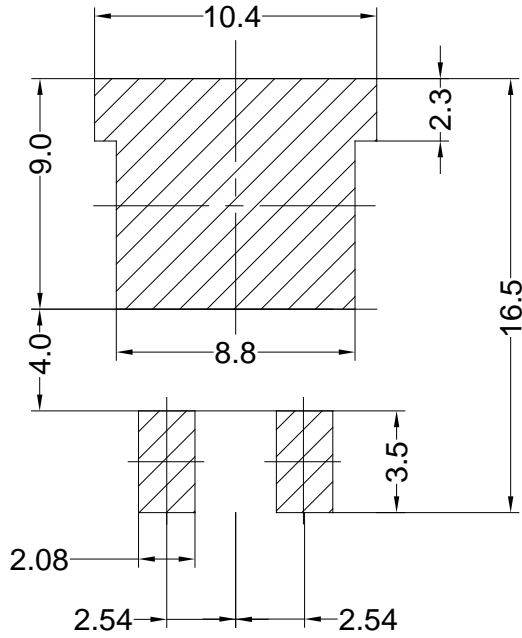

Unit:mm