

Sockets

13F-2C-B

Dimension

PCB layout

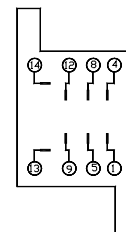
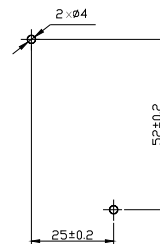
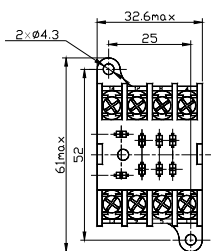
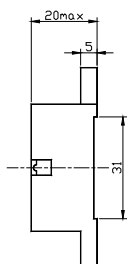

13F-2C-D1

Dimension

PCB layout

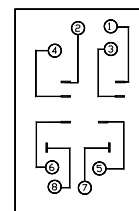
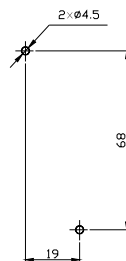
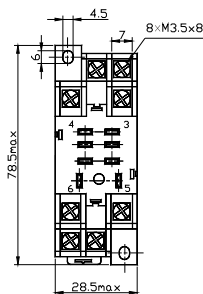
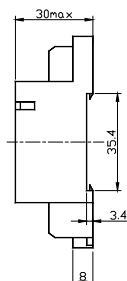

13F-2C-D2

Dimension

PCB layout

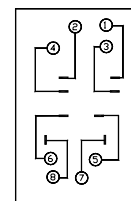
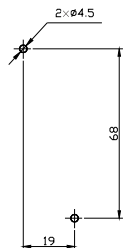
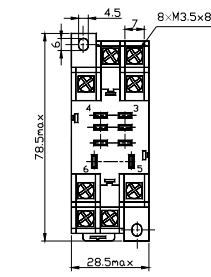
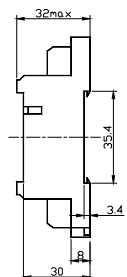

Automotive relay Socket—1

Appearance illustration

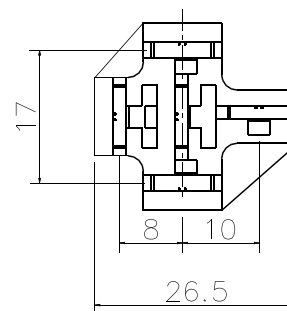
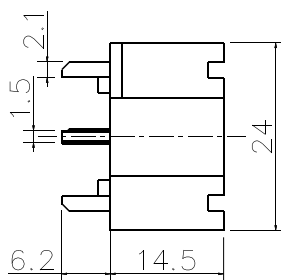

Sockets

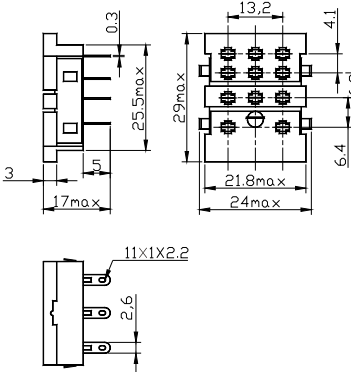
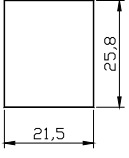
<p>18FF-3C-A1</p> 	<p>Dimension</p> 	<p>PCB layout</p> 
---	---	---

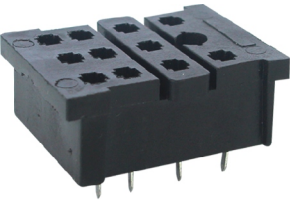
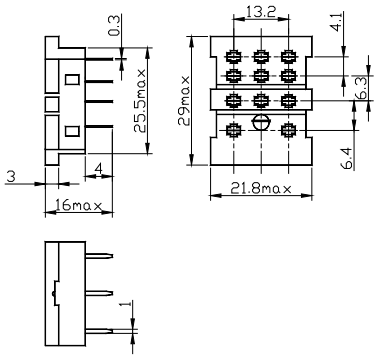
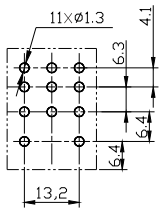
<p>18FF-3C-A2</p> 	<p>Dimension</p> 	<p>Mounting Holes</p> 
--	--	--

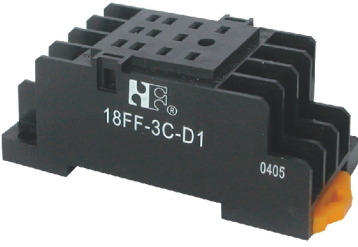
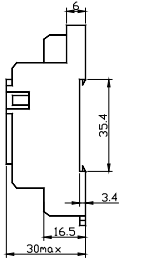
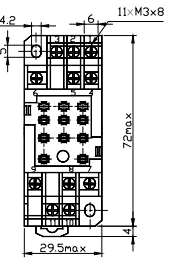
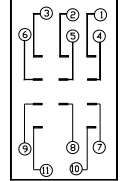
<p>18FF-3C-D1</p> 	<p>Dimension</p> 	<p>PCB layout</p> 	<p>Inter Connection</p> 
---	--	--	---

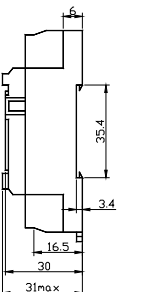
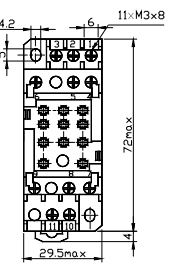
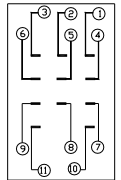
<p>18FF-3C-D2</p> 	<p>Dimension</p> 	<p>PCB layout</p> 	<p>Inter Connection</p> 
---	--	--	---

FORWARD RELAYS

Sockets

18FF-2C-A1 Dimension PCB layout

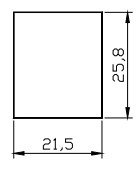
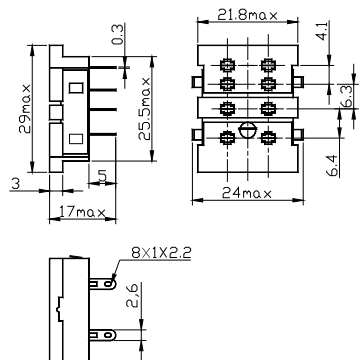

18F-2C-A2 Dimension Mounting Holes

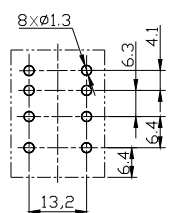
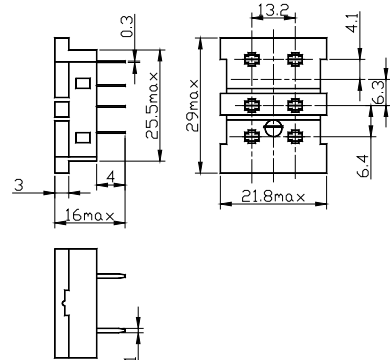
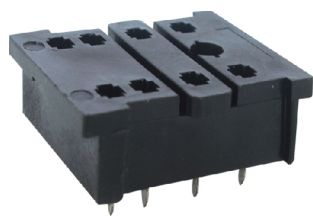

18FF-2C-D1 Dimension PCB layout Inter Connection

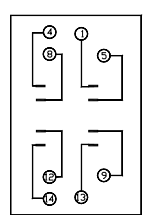
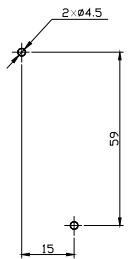
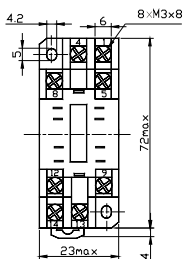
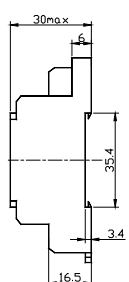
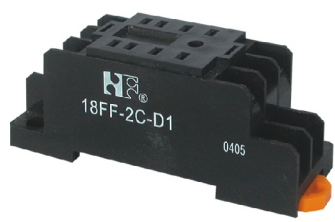

18FF-2C-D2 Dimension PCB layout Inter Connection

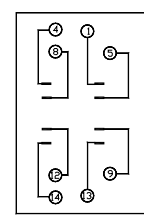
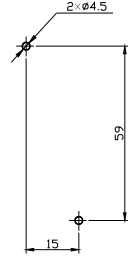
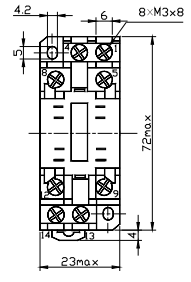
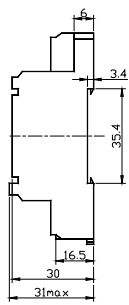

Sockets

18FF-4C-A1 Dimension PCB layout

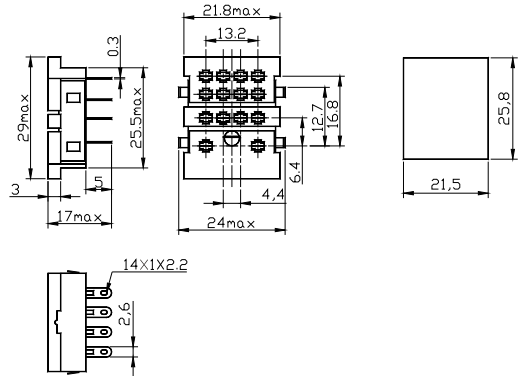

18FF-4C-A2 Dimension Mounting Holes

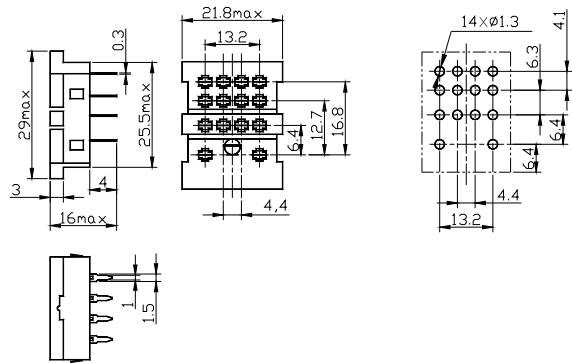

18FF-4C-D1 Dimension PCB layout Inter Connection

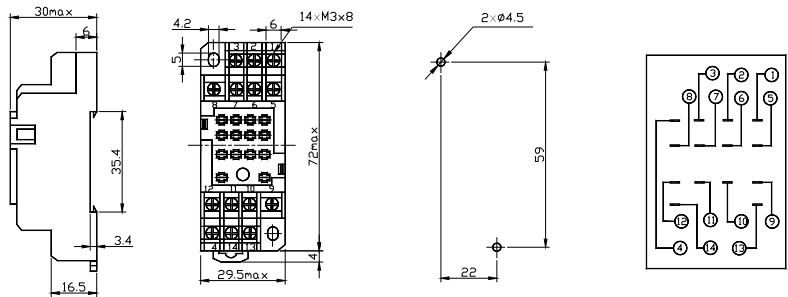
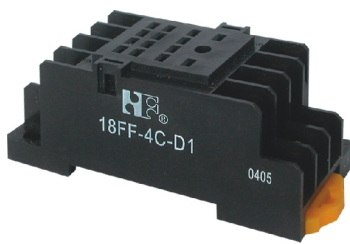

18FF-4C-D2 Dimension PCB layout Inter Connection

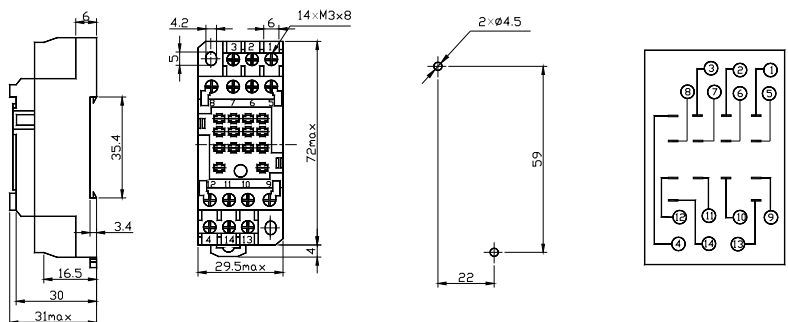

Sockets

14F-1C-A2

Dimension

PCB layout

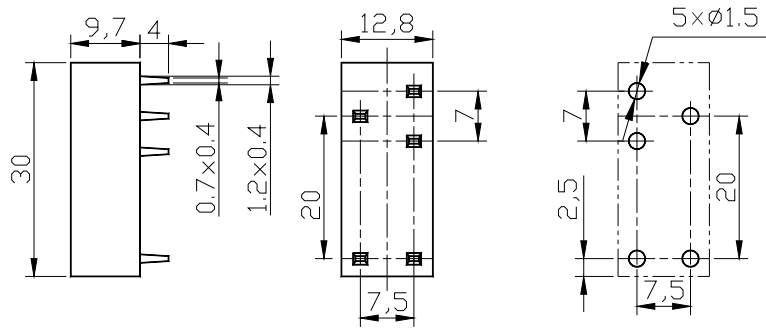

13F-2C-A

Dimension

Mounting Holes

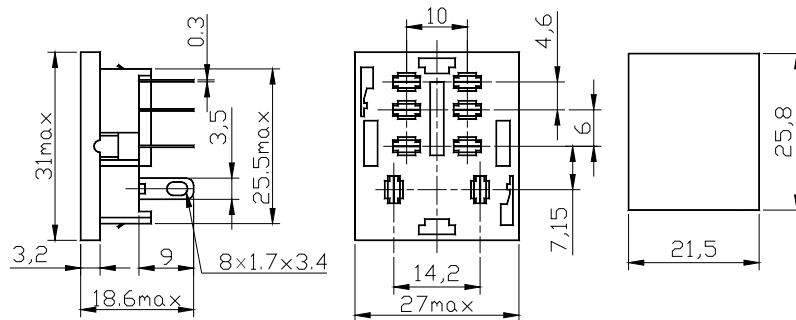

13F-2C-A1

Dimension

PCB layout

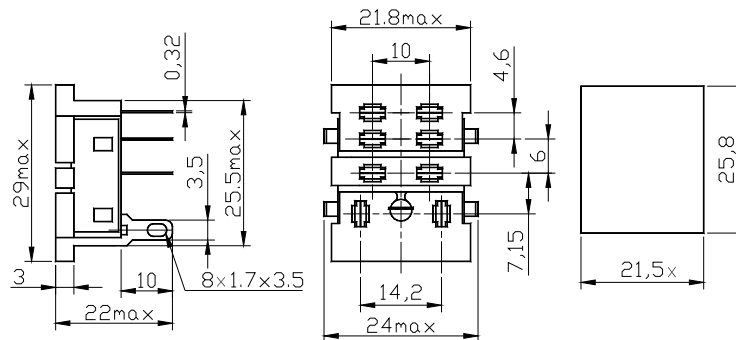
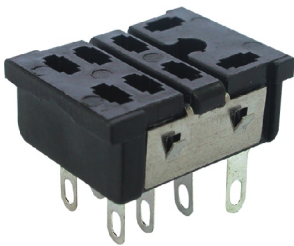

13F-2C-B

Dimension

PCB layout

